



SERVICE MANUAL
SERVICE HANDBUCH
SERVICE APRES-VENTE
MANUAL DE SERVICIO
MANUAL DE SERVIÇO





Contents

Introduction	
Basic Tooling and Material Requirements	
Fountain Pens	
General Information	1
Fault Finding Guide	3
Nibs and Their Repair	5
Repairs	6
180	9
Ms. Parker by Pucci	12
105	15
75	18
65 Convertible	23
61 Cartridge/Convertible	25
61 Capillary	23
51 Aero-Metric Mark I,	
51 Super	
21 Super	31
51 Vac-Fil	33
51 (New Style) Mark II	35
51 Mark III	36
50 Falcon	39
45	42
25	45
15, Mixy (Jotter Fountain Pen)	48
Arrow	50.1
Arrow (Revision 1-1982)	51
61, 51 Aero-Metric, 45, 15 (Jotter Ftn. Pen) Recently Manufactured Models	
FP-1	53
Premier	55
Ball Pens	
General Information	
Fault Finding Guide	
Repairs	
Barrel Assemblies	
105	
180/75/65/61/51/45/21	
61/65 Metal Barrel RHC	
50 (Falcon)	
25	
Arrow	
Arrow (Revision 1-1982)	
Minibille	
Button Actuated Cap Assemblies	
B-5, Big Arrow	
Big Red	
Premier	
Fiber Tip/Roller Ball/Floating Ball Pens	
General Information	
Fault Finding Guide	
Repairs	
180	
Ms. Parker	
105	
25	
Arrow	
Arrow (Revision 1-1982)	
Jotter	
Pencils	
General Information	
Fault Finding Guide	
Repairs	
Mechanical Mechanism, 75, 45, International Classic	
Early Manufactured 51, 21, and Super 21 Mechanical Pencil Cap	
Continuous Feed (Aero-Metric) Pencils	
Continuous Feed (UK Mechanism) 0.5 mm and 0.7 mm	
Arrow Pencil	
Arrow (Continuous Feed Pencil)	
Continuous Feed Pencil Mechanism 0.5 mm and 0.7 mm	

75, 45, Cirrus & Flighter Deluxe 15
 RBT 17
 RBT (Revision 1-1983) 19
 Premier 21

Pencils
 General Information
 Fault Finding Guide
 Repairs
 Mechanical Mechanism, 75, 45, International Classic
 Early Manufactured 51, 21, and Super 21 Mechanical Pencil Cap
 Continuous Feed (Aero-Metric) Pencils
 Continuous Feed (UK Mechanism) 0.5 mm and 0.7 mm
 Arrow Pencil
 Arrow (Continuous Feed Pencil)
 Continuous Feed Pencil Mechanism 0.5 mm and 0.7 mm

Ball Pens
 General Information
 Fault Finding Guide
 Repairs
 Barrel Assemblies
 105
 180/75/65/61/51/45/21
 61/65 Metal Barrel RHC
 50 (Falcon)
 25
 Arrow
 Arrow (Revision 1-1982)
 Minibille
 Button Actuated Cap Assemblies
 B-5, Big Arrow
 Big Red
 Premier

Fiber Tip/Roller Ball/
 Floating Ball Pens
 General Information
 Fault Finding Guide
 Repairs
 180
 Ms. Parker
 105
 25
 Arrow
 Arrow (Revision 1-1982)
 Jotter



Service Repair Manual

Introduction

The adherence to the principle of quality performance has played a major role in the continuing success of The Parker Pen Company since its founding in 1888. To maintain and enhance the Company's position of leadership in more than 130 world markets requires a high standard of performance from Parker service groups everywhere.

Quality products result in the successful conversion of design, materials, craftsmanship and service. The factors all contribute to the Parker brand image.

This detailed, yet easy to understand, worldwide *SERVICE REPAIR MANUAL* has been prepared with emphasis on *quality*. Benefits from this commitment to quality, this determination to excel, will extend far into the future.

The manual provides complete service and repair information on current Parker writing instruments and is designed to aid service technicians in their function.

Included in the manual are the following:

- **General Information**—designed to give a better understanding of Parker writing instruments.
- **Fault Finding**—to assist in pinpointing disturbances with recommendations on corrective procedures.
- **Nibs and Their Repair**—shows the correction of problems associated with nibs.
- **Basic Tooling Requirements**—with suggested lists of specialized tools and consumable materials.

The *Service Repair Manual* is intended to assist service personnel on the disassembly and assembly of Parker writing instruments to assure complete satisfaction for your customers. We urge you to discuss with the Parker representative any information in the manual that may require further clarification.

Basic Tooling and Material Requirements

Basic Common Tools



Alcohol Lamp



Bernard Fitting Pliers
Fitting nib, feed in section on pen



Nib Spacer
Adjusting nibs



Pen Cap Arbor
Removing and fitting clips on pen caps



Pencil Cap Arbor
Removing and fitting clips on pencil caps



Magnifying Glass
Inspecting, adjusting nibs



Flow Channel Cleaner



Small Screwdriver



Nib Pliers



Buff Stick Brush



Pencil Point and Barrel Drill

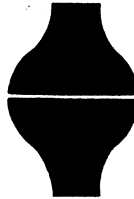

Rubber Bulb
Extracting ink



Ball Pen Arbor



Wooden Mallet

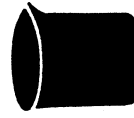

Stainless Steel Beaker and Stand

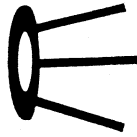

Section Pliers
Removing sections, shells from barrel of pen

Basic Tooling and Material Requirements

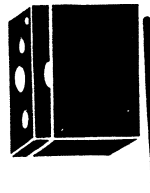

Knock Out Pin and Block



Dummy Screwdriver

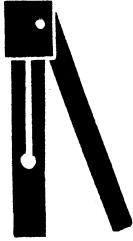

Universal Nipple Wrench
Locking filler assemblies
for gripping



Friction Palm Grip
Hand grip to hold barrel, tighten
clip screws, etc.

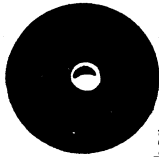

3/4" Tap Washer



Barrel Brush



Sack Stretcher



Basic Tooling and Material Requirements

Special Tools

Cell Case Staking Pliers 61 pen only	Nib Puller 51 pen	Torque Wrench	25 Ball Pen Arbor
Burnishing Rod 61 pen cell case	Pen Cap Assembly Tool 180 pen	61/65 Pen Connector Adapter	25 Fiber Tip Arbor
Assembly Tool Fitting nib, feed in 21 pens	51/61 Pen Collet 51 Mark III Collet	61/65 Pen Connector Extractor	51 Pen Feed Insertion Tool
		65 Pen Collector Tool Pre-1970	51 Pen Collector Gauge
		65 Pen Collector Tool Current	Snap Ring Removal Tool
		25 Pen Arbor	Premier Cap Tassie Tool
			Premier Friction Washer Tool

Available to Subsidiaries

Cotton Buffing and Polishing Wheel 6' or 8' diameter	Turning Tool (Carbide Tip) For bench lathe, 51 pen blind caps and 61 old style pen barrel joints	Pumice Use with polishing wheel	Centrifuge Extracting ink
Nib Grader Gauging nib grades		White Wax Polish Use with polishing wheel	

Consumable Materials

Adhesive Cementing all pens	Conditioning Powder Conditioning pen for ink flow after cleaning	Rouge Paper	Felt
Cleaning Powder/Liquid Cleaning pen parts	Metal Polish Cloth Chemically treated	Gold Engraving Crayon	45 and 65 Wax (238)
		Silver Engraving Crayon	Rouge for Buff Stick
		White Engraving Crayon	Rubber Tubing for Section Pliers
		Liquid Polish	



Service Repair Manual

Fountain Pens

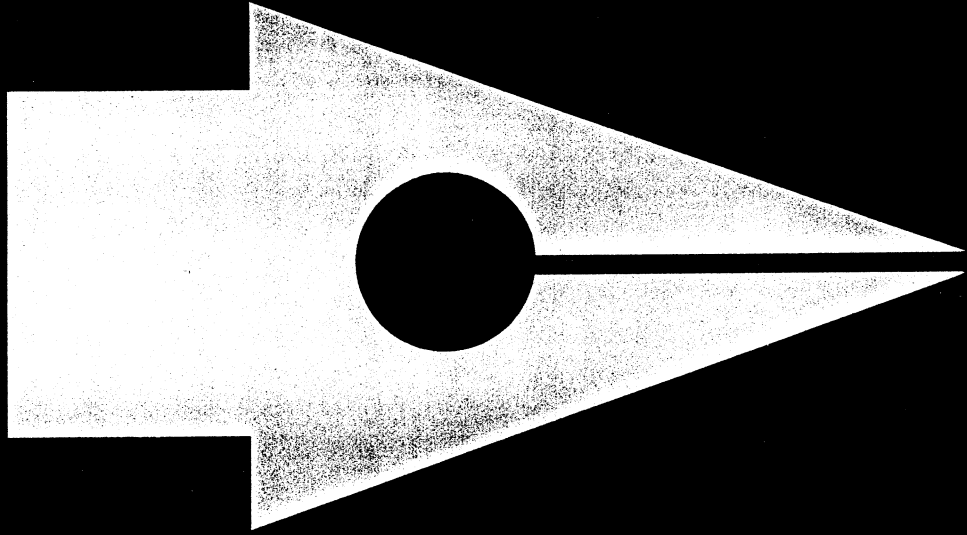

Fountain Pens

General Information

The modern fountain pen is an instrument of precision manufacture which is convenient to use, attractively styled and reliable.

It has five basic features:

1. **Case**
The case normally consists of a barrel, shell and a cap with attached clip.
2. **Reservoir**
The reservoir can be a permanent or replaceable filling type (converter) or a throwaway ink cartridge.

3. **Feed System**
The feed system basically transfers ink from the reservoir to the nib via small channels.

4. **Overflow System**
The overflow system can either be part of the feed or separate from it and it prevents the pen leaking if subjected to sudden changes in temperature or pressure.

5. **Nib**
The nib transfers ink from the feed to the paper and its design reflects the writing characteristics of a particular pen.

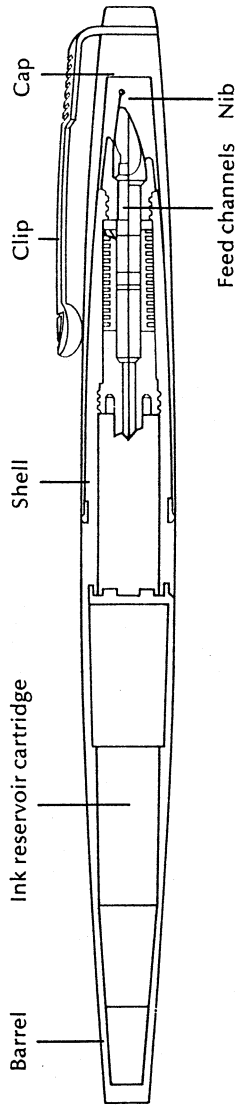

There may be slight differences in the way a particular pen

functions, but the general system is shown below:

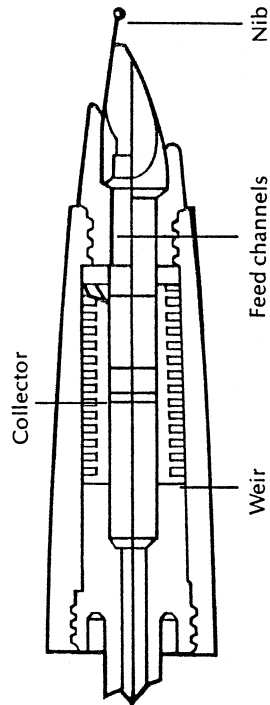

Fountain Pens

General Information

The ink which is drawn away from the nib during the course of writing, is replenished from the feed channels which take ink from the reservoir to the nib. Unless the ink which is taken from the reservoir is replaced by air, the

pen will cease to write; however, if air is made too freely available the pen will flood. Therefore, there is a control point in the feed system (known as the weir) that allows air to pass only in the required amounts. On a well designed pen, this control is so

regulated that the flow of ink from the nib to the paper appears constant. In a situation where the pen is subjected to a sudden increase in temperature or pressure, the air in the back of the reservoir expands, forcing ink excess through the feed channels.

This ink is removed from the feed by the use of an overflow system, consisting of a series of slots which fill with the excess ink. The pen is so designed that these slots empty first when the pen is being used.



Enclosed nib

The nib of a good fountain pen is made of stainless steel or gold and has a pellet made of hard-wearing alloy. The nib design determines

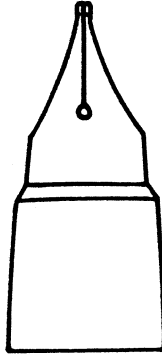

Open nib

to a large extent the writing pattern. Various nib grades provide different widths and line profiles. Generally speaking, an enclosed nib will be satisfactory

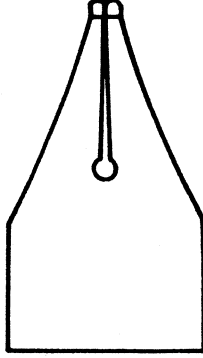

Closed points

for a person who writes with a heavy hand more readily than an open nib.

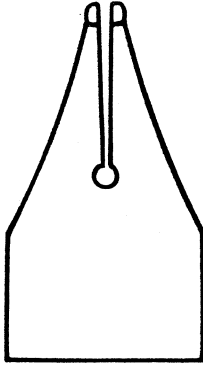

Open points

Fountain Pens

Fault Finding Guide

In many cases, a repair or adjustment can be carried out "on the spot" since some problems are easy to recognize. However, if the pen will not write, the following basic approach should be adopted:

1. Flush the pen with cold, clear water.
2. Fill the pen with a fresh supply of ink.
3. Start ink flow by writing with pen.

If the pen does not perform satisfactorily after performing the above, you may refer to the following chart to diagnose the problem and take corrective action.

Complaint	What to look for	What to do
Pen will not fill	Filling procedure not being followed correctly Defective reservoir Pen clogged with foreign matter Pen incorrectly assembled	Follow filling instructions (with customer) Fit new reservoir Clean pen thoroughly Rectify as necessary
Pen difficult to start	Cap left off pen for length of time Defective cap fit Damaged nib Nib or feed contaminated or clogged Nib incorrectly matched to mating parts	Flush ink through pen See below Replace nib Clean pen thoroughly Overhaul pen replacing faulty parts as necessary
Pen does not write or has erratic flow	No ink in pen Converter or cartridge not seated Nib incorrectly matched to mating parts Damaged nib Defective cap fit	Fill pen Push fully home Overhaul pen replacing parts as necessary Replace nib See below

Fountain Pens

Fault Finding Guide

Complaint	What To Look For	What To Do
Ink flows too freely	Customer writes with heavy pressure Pen almost empty Open nib points Damaged nib Feed loose or distorted	Advise nib change to finer grade Fill pen Overhaul pen and repair or replace nib Replace nib Overhaul pen replacing parts as necessary
Pen floods, leaks or blots	Leaking from rear of shell Split cartridge/converter plug Pen almost empty Loose converter or cartridge Internal parts contaminated or damaged External parts damaged Sealed joints ineffective	Replace faulty parts and reseal Replace cartridge/converter Fill pen Ensure fully home Clean or replace as necessary
Scratchy nib	Split cartridge/or converter plug Nib damaged Nib offset Nib too flexible	Replace as necessary Renew adhesive and parts as necessary Replace cartridge/converter Replace nib Reset or replace nib as necessary Replace nib
Poor cap fit	Wrong cap on pen? Cracked or damaged cap Damaged or ineffective clutch Damaged inner cap	Fit correct cap Replace cap Replace clutch and inner cap Replace inner cap

Fountain Pens

Fault Finding Guide

Complaint	What To Look For	What To Do
Poor barrel fit	Cracked or damaged barrel Worn barrel threads Loose liner Damaged connector threads	Replace barrel Replace barrel liner Renew adhesive Replace connector
Ineffective clip	Broken or damaged clip Loose clip Sprung clip Wrongly assembled clip	Replace clip Reassemble cap using new adhesive Replace clip Reassemble cap using new adhesive

Nibs and Their Repair

The nib of a good fountain pen is made of stainless steel or gold and has a pellet made of hard-wearing alloy. The nib design determines to a large extent the writing pattern. Various nib grades provide different widths and line profiles. Generally speaking, an enclosed nib will be satisfactory for a person who writes with a heavy hand more readily than an open nib.

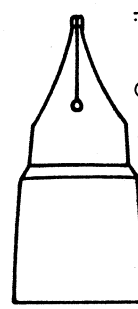
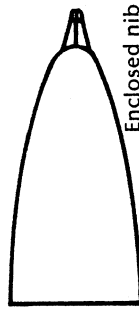

Common Problems

1. Ink Flow
When there is a problem of ink flow, check the pen points. If there is insufficient flow, the points will probably be close together; if there is excessive ink flow, the points may be too far apart.

2. Lack of Smoothness
One other major area of nib failure is lack of smoothness. This often occurs when some minor damage has been sustained by the nib to cause the points to be out of alignment.

Another cause of roughness can be the result of a nib that has not been fully polished—especially on the inside of the slit. The judicious use of rouge paper will correct this problem. Nib polishing must be done properly to avoid unacceptable flat surfaces on the face of the nib.

3. Damaged Nib
If the nib has been damaged, it is preferable to replace the nib rather than to attempt repair. It is recommended that neither the feed nor the collector be handled.



Service Repair Manual

Fountain Pens

180 Fountain Pen

Repairs



Fountain Pens

180 Fountain Pen

Exploded Drawing

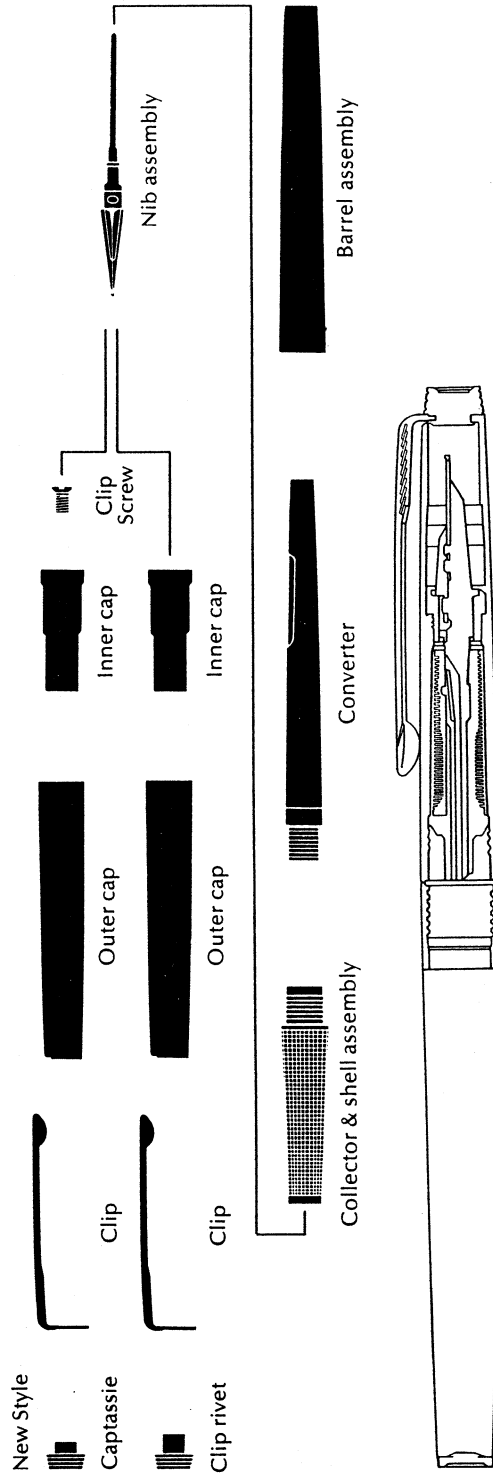

Repairs to this model are limited to cap assembly, mainly the

replacements of the clips, and performing minor adjustments on the nib.

Disassembly

1. Remove the cap and barrel.
2. If the pen is equipped with a converter, extract the ink and remove the converter or, in the case of a cartridge, remove the cartridge.
3. Remove the nib assembly by pulling straight out (it is not threaded).
4. Do not handle the back end of the feed.
- *5. Since the 180 stainless steel and older style 180 cap is held with a clip rivet instead of a clip screw, the first step is to remove the rivet. This requires a drill press and drilling out the clip rivet from inside the cap, using a 3/16" drill. If a drill press is not available, it can also be accomplished by clutching the cap

6. The following repair instructions are for the new, redesigned 180 Vendome pen cap assemblies.
 - a. With a small screw driver remove the cap tassie screw from inside the cap.
 - b. Once the screw has been removed, the inner cap, clip and cap tassie can be easily removed from the outer cap.

*NOTE: Replacement is recommended.

Fountain Pens

180 Fountain Pen

Assembly

1. Insert the nib assembly into the shell assembly by pushing straight in.
 2. Replace the converter and fill with cleaning solution. Then use a centrifuge to clean out the solution.
 3. Fill the pen with ink and test for smoothness and flow.
 4. After proper adjustments are made, remove ink by centrifuge, fill with cleaning solution and remove by centrifuging again. Then fill with conditioner and centrifuge again.
5. To assemble the cap:
 - a. Assemble the two-part tool, small end of the sleeve so that the head of the rod is at the smaller end of the sleeve.
 - b. Insert the clip into the top of the outer cap making certain that the top of the feathered part of the clip is resting in the notched out slot.
 - c. Insert the inner cap into the large open end of the outer cap.
 - d. Place the rivet on a hard surface (a block of wood is ideal), large end down and fit the previous assembled parts (cap and inner cap) over the small end
6. The following repair instructions are for the new, redesigned 180 Vendome pen cap assemblies.
 - a. First insert and position the clip into the notched area of the outer cap.
 - b. Insert the cap tassie screw into the large end of the inner cap; and, while holding the clip in place, insert the two parts into the outer cap with a small screw driver.
 - c. Apply a small amount of adhesive to the protruding threads of the cap tassie screw and start the cap tassie onto the screw.
 - d. Tighten the screw firmly by applying pressure against the cap tassie with a friction palm grip.

Nib Adjustment

1. When replacing the nib assembly, the original one can be removed by grasping the nib and feed and pulling them straight out from the shell assembly. This can be accomplished by using your fingers along with a friction palm grip. The new assembly can be installed by reversing the above procedures.
2. As indicated, only minor adjustments can be performed on the nib since the complete assembly is factory assembled. When adjusting or spacing is necessary, care should be taken so as not to change the relationship between the nib and feed.

Tools Required

1. Alcohol lamp or gas jet.
2. Pen cap assembly tool.
3. 3/4" tap washer.
4. Friction palm grip.
5. Nib spacer.
6. Nib pliers.
7. Bernard pliers.



Service Repair Manual

Fountain Pens

Ms. Parker by Pucci
180 Fountain Pen

Repairs



Fountain Pens

Ms. Parker by Pucci
180 Fountain Pen

Exploded Drawing

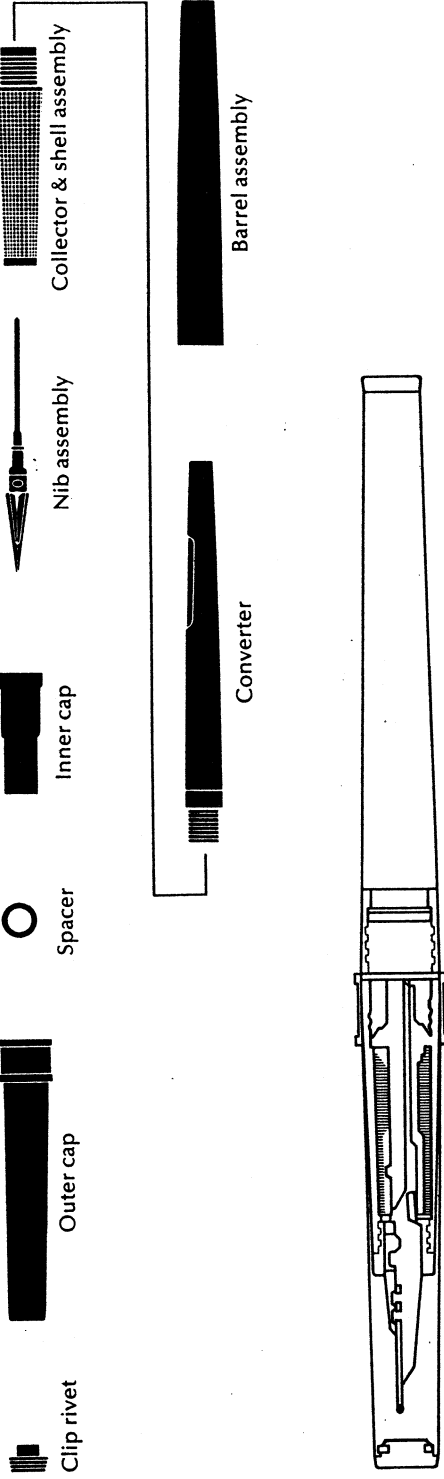



Fountain Pens

Ms. Parker by Pucci
180 Fountain Pen

Disassembly

1. Remove the cap and barrel.
2. If the pen is equipped with a converter, extract the ink and remove the converter or, in the case of a cartridge, remove the cartridge.
3. Remove the nib assembly by pulling straight out (it is not threaded).
4. Do not handle the back end of the feed.
5. Since the inner cap is held with a clip rivet instead of a clip screw, the first step is to remove the

rivet. This requires using a drill press and drilling the clip rivet out from inside the cap with a 3/16" drill or, if a drill press is not available, it can also be accomplished by clutching the cap assembly in a bench lathe. It should be pointed out that the operator's hands are exposed to

some danger during the drilling operation and, therefore, caution should be taken.

6. Once the clip rivet is removed, the remaining parts of the cap assembly (inner cap spacer and cap) can easily be disassembled.

Cap Assembly

1. Assemble the two-part tool, small end of the rod through small end of the sleeve so that the head of the rod is at the smaller end of the sleeve.

and inner cap) over the small end of the clip rivet. The loosely assembled parts are now standing on the block of wood with open end of cap up.

open end of the cap with the head part of the rod first. By holding the sleeve part of the tool firmly and pressing down, the cap parts will be held correctly in place. Next strike the small end with a hammer. This should complete the assembly operation.

4. Holding all the cap parts firmly in place insert the tool into the

Nib adjustment

1. When replacing the nib assembly, the original one can be removed by grasping the nib and feed and pulling them straight out from the shell assembly. This can be accomplished by using your fingers along with a friction palm grip. The new nib assembly can be installed by reversing the above procedures.

2. As indicated only minor adjustments can be performed on the nib since the complete assembly is factory assembled. When adjusting or spacing is necessary, care should be taken so as not to change the relationship between the nib and feed.

Tools Required

1. Alcohol lamp or gas jet.
2. Pen cap assembly tool.
3. 3/4" tap washer.
4. Friction palm grip.
5. Nib spacer.
6. Nib pliers.
7. Bernard pliers.



Service Repair Manual

Fountain Pens

105 Fountain Pen

Repairs



Fountain Pens

105 Fountain Pen

Exploded Drawing

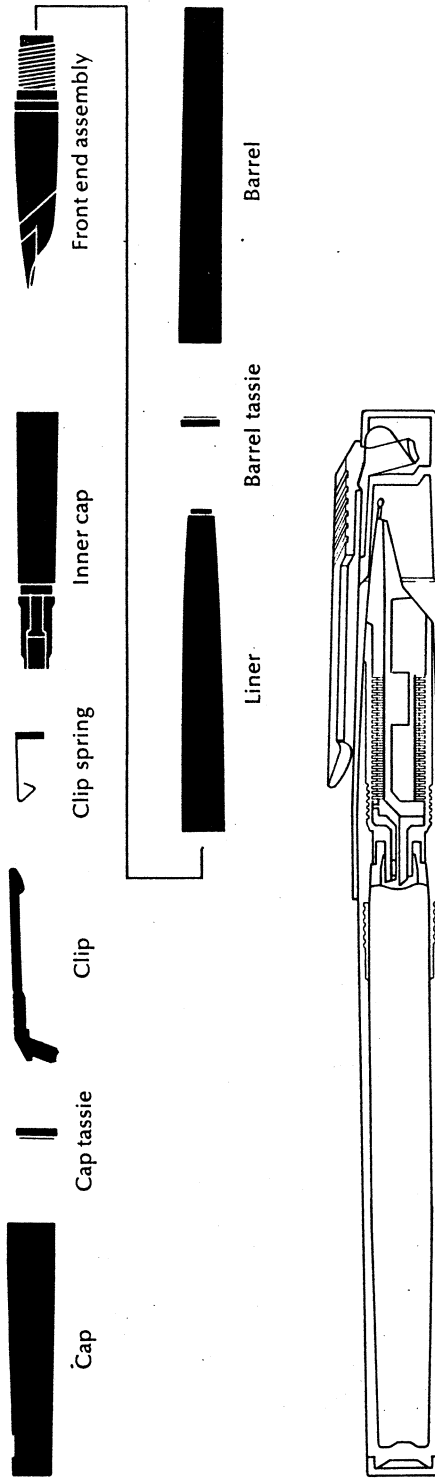

Fountain Pens

105 Fountain Pen

Disassembly

1. Remove the cap and barrel.
2. If pen is equipped with a converter, extract the ink and remove the converter; or, in the case of a cartridge, remove the cartridge.

When carrying out the nib grade changes, ensure that assemblies fit for re-use are washed out before storing.
3. Front end is only available as a complete assembly. Thus, disassembly and assembly can not be satisfactorily carried out in the field.
4. To disassemble the cap assembly, carefully pull the clip outward until the clip spring collapses. Holding clip at right angles to the cap, press the inner cap toward the open end of the cap.
5. To remove barrel liner, heat the large end of the barrel over a flame and grip the barrel with a nib pliers. Heat the barrel evenly and twist the barrel free. Reheat as necessary and remove remaining adhesive.

Assembly

1. To reassemble the cap, replace the inner cap and clip spring as necessary. Position the clip into the cap, refit inner cap ensuring that the clip screw lines up with the clip. Push inner cap fully home using a pencil cap arbor.
2. To replace barrel liner, apply adhesive to the liner and push home with the shell assembly.

Tools Required

1. Alcohol lamp or gas jet.
2. Pencil cap arbor.
3. Nib spacer.
4. Nib pliers.



Service Repair Manual

Fountain Pens

75 Fountain Pen

Repairs



Fountain Pens

75 Fountain Pen

Exploded drawing

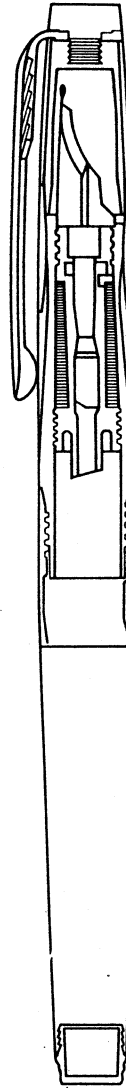
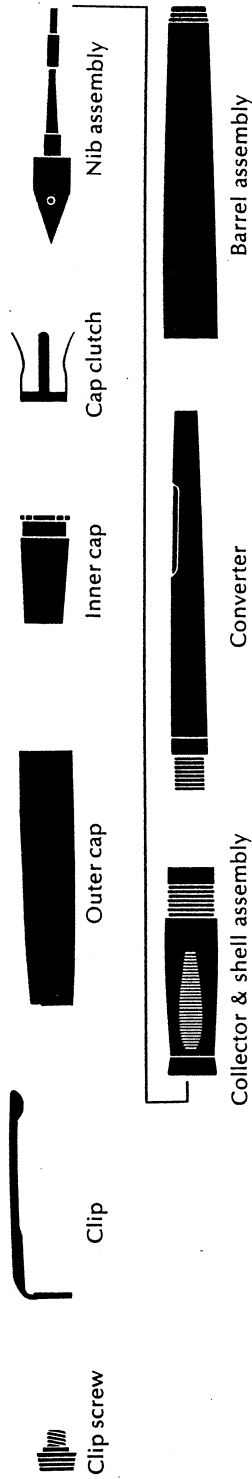

Fountain Pens

Disassembly

1. Remove the cap and barrel.
2. If the pen is equipped with a converter, extract the ink and remove the converter; or, in the case of a cartridge, remove the cartridge.
3. Remove the nib assembly by pulling straight out (it is not threaded).
4. Do not handle the back end of the feed.
5. To disassemble the cap, insert the pen cap arbor into the inner cap and turn the inner cap counterclockwise while holding the top of the cap, along with the clip screw and clip, with a 3/4" tap washer or friction palm grip.

Assembly

1. Insert the nib assembly into the shell assembly by pushing straight in.
2. Replace the converter and fill with cleaning solution. Then use a centrifuge to clean out the solution.
3. Fill the pen with ink and test for smoothness and flow.
4. After proper adjustments are made, remove ink by centrifuge, fill with cleaning solution and remove by centrifuging. Then fill with conditioner and centrifuge again.
5. To assemble the cap:
 - a. Assemble the inner cap and clutch and insert these parts into the cap with a pen cap arbor.
 - b. Insert the clip in the cap so that the clip is resting in the notched out portion of the cap. In sterling silver pens of early manufacture it is the clip screw that is notched—not the cap—in which case fit the clip into the notch of the clip screw.
6. Apply adhesive to the threads of the clip screw and place into position on the cap. (The clips of sterling silver pens of early manufacture have a lug at the back which must line up and lock into the slot in the cap. This can be accomplished by raising the ball of the clip up and away from the cap.)
7. Hold the clip screw in this position and turn the inner cap clockwise with the pen cap arbor.
8. Tighten firmly, then check the position of the clip to be sure it remained in position and lined up with the Parker stamp at the bottom of the cap except on caps where stamp is opposite clip.

Due to the particular design of the 75 nib and the very exacting tolerances, if one comes in that is even slightly sprung be careful in adjusting it—it can be very easily and permanently sprung out of tolerance.
See section entitled "Nibs and Their Repair," page 5.
See section entitled "Fault Findings," page 5.

Tools Required

1. Alcohol lamp or gas jet.
2. Pen cap arbor.
3. 3/4" tap washer.
4. Friction palm grip.
5. Nib pliers.
6. Bernard pliers.

Fountain Pens

65 Fountain Pens

Repairs





Service Repair Manual

Fountain Pens

65 Fountain Pens

Exploded Drawing

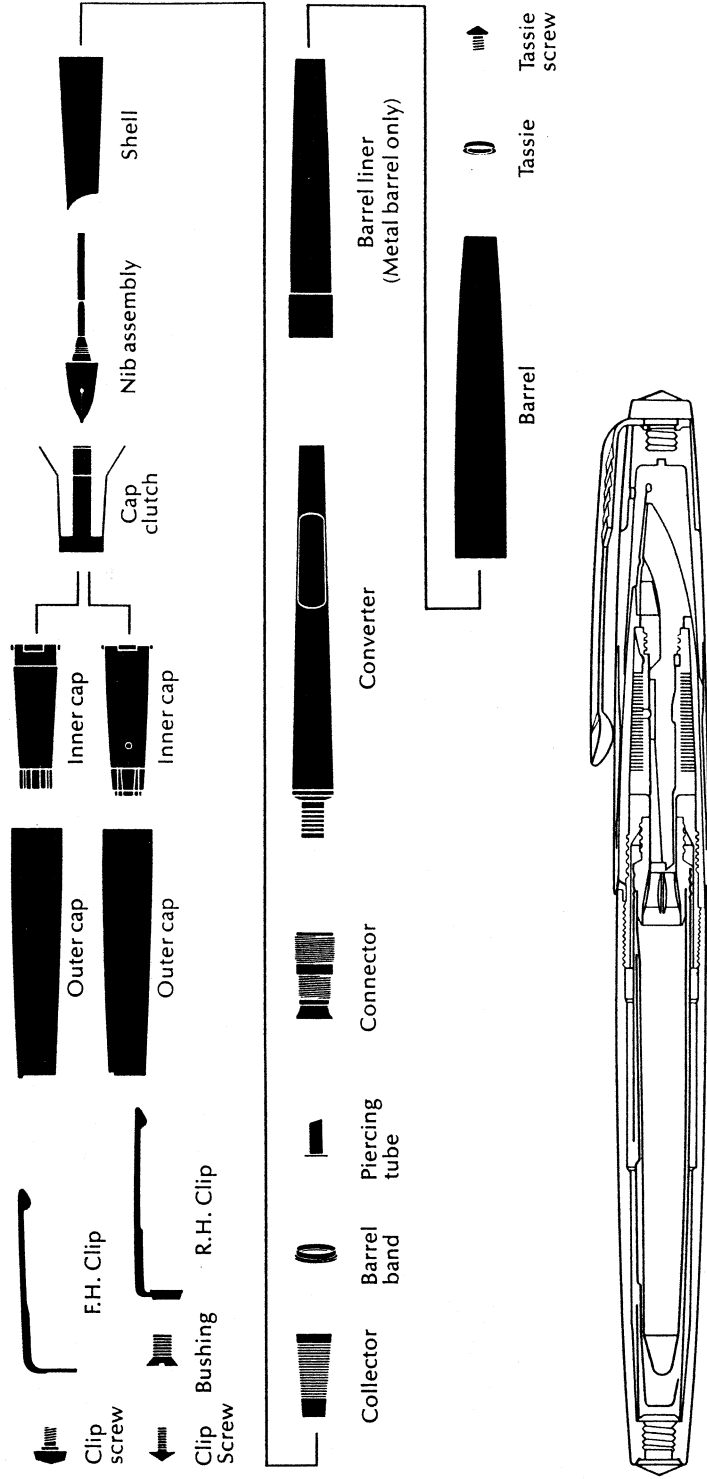



Service Repair Manual

Fountain Pens

65 Fountain Pens

Fountain Pens

65 Convertible Fountain Pen



Front End Disassembly

1. Remove the cap and barrel.
2. If the pen is equipped with a converter, extract the ink and remove the converter, or, in the case of a cartridge, remove the cartridge.
3. To disassemble, remove the connector assembly. Follow procedure used in 61 connector removal.

4. Using the collector tool unscrew the collector. The nib assembly will separate from the shell.

DO NOT REMOVE NIB FROM FEED.

Front End Assembly

1. To make a correct seal between the feed and the collector, shell wax must be applied to the shoulder of the feed.
2. Melt the wax and apply with a pencil brush. The wax must not come into contact with the nib nor be allowed to enter the feed slots.

3. Locate the nib unit in the recess at the front of the collector shell and line up the point of the nib with the point of the shell. Place the collector into the back of the shell and using the collector tool screw in the collector firmly.
4. Check the alignment of the nib to the shell and correct if necessary.

5. Remove the excess wax and do not allow this to come into contact with the nib.
6. Fit the barrel band to the connector assembly and apply adhesive to threads. Turn connector to shell assembly lightly with fingers and tighten fully with torque wrench. Push barrel bands against shell using collet and remove excess adhesive with B.P. Spirit.

7. Fit barrel band to connector assembly and apply adhesive to threads. Screw connector to shell assembly lightly with fingers, and tighten fully using torque wrench. Push barrel band against shell using collet and remove excess adhesive with B.P. Spirit.

Cap Disassembly

1. There are two types of cap assembly, the FHC identified by a metal clip screw and the RHC identified by the plastic clip screw. With the exception of the clutch, the components are not interchangeable. Barrels are fitted with matching tassie screws.

2. To dismantle, heat clip screw over gas jet or alcohol lamp, unscrew using a tap washer or friction palm grip.

Cap Assembly

1. To assemble, position clutch over inner cap and place on cap arbor. Fit clip to cap with ring under flange of cap, insert inner cap and clutch using arbor.

3. The Cirrus inner cap has a revolving brass bushing in the top and is fitted with a spring ring clutch instead of the standard four-fingered clutch.

Cap Disassembly RHC

1. To dismantle, remove plastic screw with friction palm grip, or burn out over gas jet or alcohol lamp.

2. Remove brass bushing with small screwdriver.

Cap Disassembly KHC

1. To disassemble, remove plastic screw with friction palm grip, or burn out over gas jet or alcohol lamp.

4. Remove brass bushing with small screwdriver.

Cap Assembly RHC

1. To assemble, position clutch over inner cap and place on cap arbor. Fit clip to cap with lug of cap under clip and insert inner cap and clutch in cap. Apply adhesive to thread of inner cap and fit bushing.

2. Apply adhesive to bushing and fit clip screw.

Barrel Disassembly (Metal)

1. To remove barrel liner, heat large end of barrel over gas jet or alcohol lamp and grip inner barrel with nib pliers.

2. Heat the barrel evenly and twist the barrel liner free.

3. Reheat if necessary and remove remaining adhesive.

Barrel Assembly (Metal)

1. To assemble, apply adhesive to narrow end of new inner barrel and push home with connector.

2. Fit matching tassie screw using rubber solution and tap washer or friction palm grip.

3. Remove excess adhesive from barrel.

Tools Required

1. Alcohol lamp or gas jet.
2. Pen cap arbor.
3. 3/4" tap washer.
4. Friction palm grip.
5. Torque wrench and connector adapter.

6. Universal nipple wrench and "51" collet.
7. Nib spacer.
8. Nib pliers.
9. Bernard pliers.

PARKER

Service Repair Manual

Fountain Pens

61 Fountain Pens



Fountain Pens

61 (Cartridge/Convertible) Fountain Pen

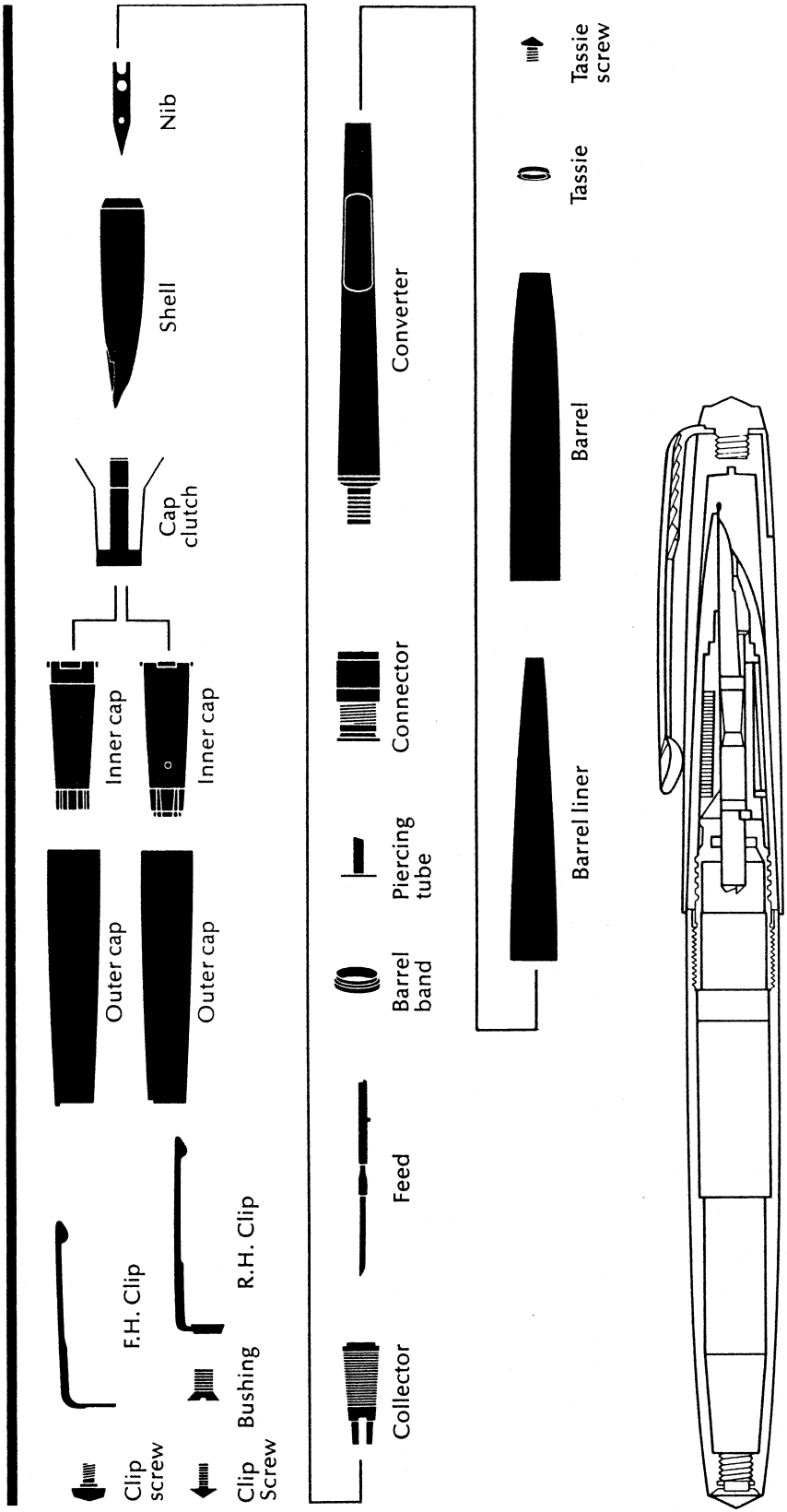

Fountain Pens

61 (Cartridge/Convertible) Fountain Pen

22

Disassembly

1. Remove the cap and barrel.
2. If the pen is equipped with a cartridge, remove the cartridge.
3. To dismantle, hold shell with friction palm grip and unscrew connector with the universal nipple wrench fitted with "Aero" collet.
4. If necessary, heat connector end of shell in hot water to break seal.
5. To remove nib assembly from shell, press the point of nib gently but firmly on hard surface. If necessary, soak in water and repeat.
6. Remove nib from collector by pulling straight out.
7. Remove feed from back end of collector.
8. Press barrel band from connector using back end of nipple wrench collet.

Assembly

1. Before assembly, ensure that nib points are set and that tongue of feed does not curl away from nib.
2. Fit feed to collector from the back, fit nib to feed/collector from the front.
3. Fit assembly into shell.
4. Fit barrel band to connector assembly and apply adhesive to threads.
5. Screw connector to shell assembly lightly with fingers, and tighten fully using torque wrench.
6. Push barrel band against shell using collet and remove excess adhesive with B.P. Spirit.

Tools Required

1. Alcohol lamp or gas jet.
2. Pen cap arbor.
3. 3/4" tap washer.
4. Friction palm grip.
5. Torque wrench and connector adapter.
6. Universal nipple wrench and 51 collet.
7. Nib spacer.
8. Nib pliers.
9. Bernard pliers.

Fountain Pens

61 (Capillary) Fountain Pen

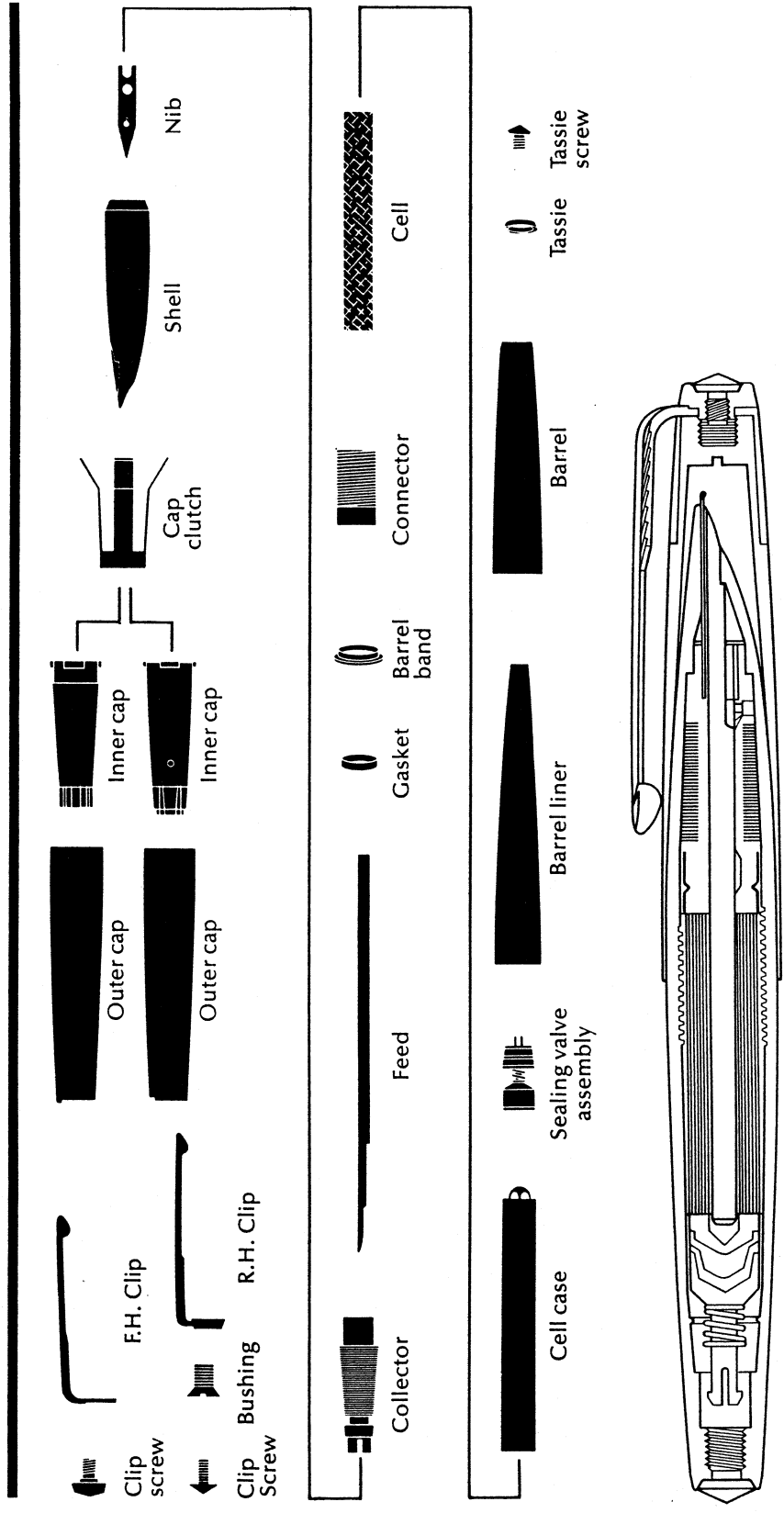

PARKER

Service Repair Manual

Fountain Pens

61 (Capillary) Fountain Pen



Fountain Pens

61 (Capillary) Fountain Pen

Disassembly

1. Remove the cap and barrel.
2. Extract ink, preferably with a centrifugal ink extractor. Grasp the metal threads of the connector with a universal nipple wrench and grasp the shell with the friction palm grip in the palm of your hand. Pressing the lever of the universal nipple wrench, unscrew the connector.

3. Note the shell does not turn as in the other shell-equipped pens. The connector, which serves to hold the barrel on one end holds the shell on the other and will spin freely around the cell case. Remove the shell straight out. The sealing gasket can be pulled off the cell case only on the old style models.

4. Remove the nib by pulling it straight out of the feed and collector. The feed is heat-staked to the cell on new pens but may be extracted by twisting it counterclockwise and then pulling it straight out of the collector.

5. If it is necessary to change a collector or cell, you must remove the collector from the cell case.
NOTE: The cell case is staked to the collector neck by three equidistant indentations. Twist and pull to remove the cell case. Care must be taken to avoid breaking the collector.

6. To remove the cell foil, tap the cell case against a hard surface. The cell should not be pulled out with any tool, as it may be damaged. Old cell foils can be used when in good condition and properly cleaned in cleaning solution and reused in clear water. It is preferable to use a new one if possible.

7. Clean all parts properly and rinse thoroughly in clean water and examine carefully. Avoid touching the feed, collector or cell foil with your hands or dirty rags. Contact with these parts may affect the performance. Clean white gloves are recommended. Replace all damaged parts.

Note: Conversion to 61 convertible should be made when pen is not filling. This is due to parts being unobtainable.

Assembly

1. The indentations caused by staking the cell case to the collector may be removed by burnishing them from the inside of the cell case with a burnishing rod.

2. Insert the foil all the way into the cell case, exercise care not to contaminate it. Do not twist or bend foil. Place the feed in the collector. NOTE: A small stake mark on the surface of the feed. This stake mark must be aligned with the stake mark (depression) on the shoulder of the collector.

3. Insert the collector, so that the opening of the cell case and the feed goes into the center or core of the cell foil roll.

4. Place the jaws of the cell case staking pliers over an alcohol lamp or gas jet for 30 seconds to heat them. Then, insert the cell case into the jaws of the cell case staking pliers, bringing the tool all the way to the collector end of the cell case. The tool has three equidistant set screws, the points of which must barely protrude on the inside surface of the jaws. This tool must be placed on the cell case in such a manner that the set screws are closest to the collector end of the cell case. Align one of the screws with the wide channel

of the collector, exert enough pressure to depress the metal with the tips of the three screws.
Note: One of the screws must be in line with the wide channel to prevent any of the depressions from falling on the narrow slit of the collector which is exactly opposite the wide channel. If this were to happen, the ink flow would be affected.

5. Place the nib over the feed onto the collector until the lug in the nib engages the small indentation in the collector.

Note: If you have used a new feed, you must immerse the front end of the assembly, up to 3.2 mm of the collector, using fresh boiling water for 5 seconds. Allow air to cool. If you have replaced the nib, you must immerse the front end of the collector, less the nib, into salt saturated boiling water for 5 seconds. Air cool, place nib into the collector over the feed and immerse for 5 seconds in fresh boiling water. Air cool.

6. Replace the sealing gasket with a new one, and install it over the cell case, against the collector and insert the connector and barrel band. Notice that the sealing gasket has one of its edges beveled in. This end must be against the beveled edge of the connector.

Note: Old style only. On new style units sealing gasket must be placed on cell case before staking the collector.

7. Insert the collector shell over the nib. Put some cement over the connector threads; and with the universal nipple wrench, thread the connector all the way into the shell. Do not exert excessive pressure, as it may cause the shell to crack. Place barrel band over connector and against shell. The connector threads must be free of old cement. Special care must be exercised in cleaning out these threads prior to assembly.

8. After the pen has been completely assembled, fill with conditioning solution and centrifuge. Fill the pen with ink to test for smoothness and flow. Condition pen and centrifuge before returning to owner.

9. The barrel of the 61 pen contains a sealing valve. If it is necessary to exchange this valve, remove the tassie screw and barrel tassie by holding a friction palm grip in the palm of your hand and pressing the screw end of the barrel against the grip. Then, turn the barrel in the same manner you do to remove a clip screw from a pen cap.

10. Insert a rod into small end of barrel and push it in to dislodge valve through the wide end of barrel. Insert new sealing valve into barrel and force into position using a small rod.

ools Required

1. Alcohol lamp or gas jet.
2. Friction palm grip.
3. Universal nipple wrench.
4. Nib plier.
5. Nib spacer.
6. Stainless steel beaker.
7. 61 burnishing rod.
8. 61 cell case staking pliers.
9. Torque wrench.
10. 61/65 connector adapter.
11. 61/65 connector extractor.

Fountain Pens

51 Aero-Metric Mark I, 51 Special and Super 21

Repairs



Fountain Pens

51 Aero-Metric Mark I, 51 Special

Exploded Drawing

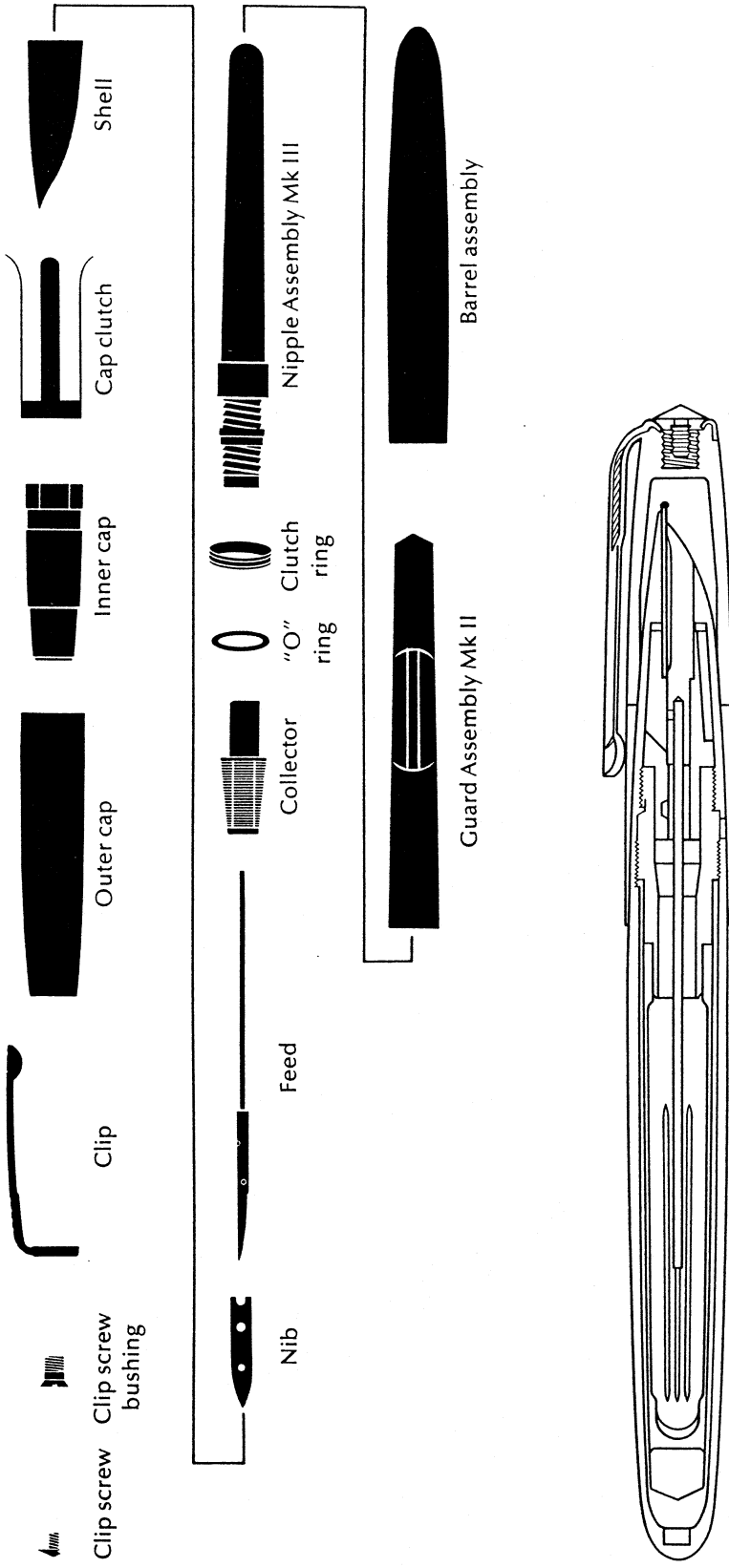

Fountain Pens

51 Aero-Metric Mark 1, 51 Special and Super 21

Disassembly

1. Remove the cap and barrel.
2. Extract ink, preferably with a centrifugal ink extractor. Place the universal nipple wrench on the nipple threads and grasp the shell with a section pliers.
3. With pressure on the lever of the universal nipple wrench, unscrew the shell all the way and remove from front end of pen (see illustration).



3. Pull out and discard the nipple assembly. Once the pen has been completely disassembled, all the parts should be immersed in a cleaning solution. Rinse all parts in clear, cold water and dry properly. All parts should be carefully inspected for distortion, cracks or presence of foreign matter. If parts prove to be in good condition, proceed to assembly of pen.

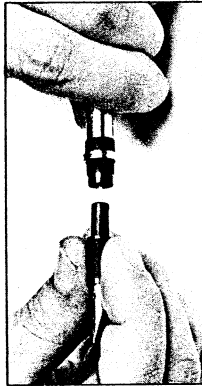

6. Take particular care in examining the flow channels and breather tube making sure they are clear of foreign matter. The feed flow channels may be cleaned with a spacing steel (see illustration). The same care must be exercised when examining collector. All fins must be intact and clean. Replace any defective parts.

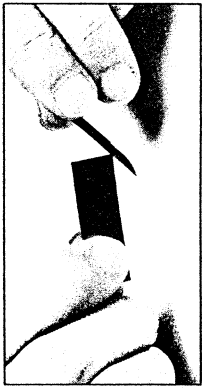

Assembly

1. Slip clutch ring over front end on neck of the nipple. Next, on 51 pens, insert the "O" ring. It is advisable to replace the "O" ring with a new one.
2. Place the nib over the feed in proper alignment. The air hole and slit in the feed should be aligned with the pierce and slit of the nib. Holding the assembly with thumb and forefinger, introduce it into the collector until the feed and nib reach

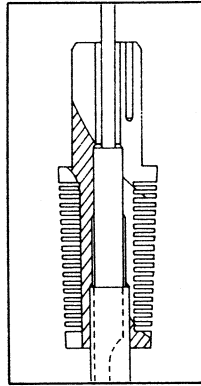

the shoulders built inside the collector to accommodate these parts. The diagram shows proper positioning.

3. Place nib-feed-collector assembly inside open end of the nipple and guard assembly. If it was necessary to disassemble the nipple and guard assembly, fit the Mark III nipple assembly to a Mark II guard, holding the guard upright and supporting with fingers while tapping the nipple assembly home with a mallet. The collector should fit snugly into this opening. Apply adhesive evenly on threads of the nipple and guard assembly. In some cases nib and shell tip will not

- align. When this happens, remove shell and rotate collector to a position where nib will align with shell.
4. Follow instructions on nib adjustment on page 5 and fill pen with ink in prescribed manner.
5. After filling pen, place a cloth or absorbent tissue against tip of nib for a few seconds to extract excess ink.
6. Test pen for flow and smoothness of nib.

1. Universal nipple wrench.
2. Section pliers.
3. Feed channel cleaner.

7. Nib pliers.
8. Nib spacer.

Tools Required

Fountain Pens

51 Vac-Fill Fountain Pen

Repairs



Fountain Pens

51 Vac-Fill Fountain Pen

32



Clip screw

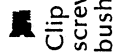

Clip screw bushing



Clip



Outer cap



Inner cap

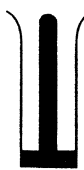

Clutch



Collector shell



Nib



Feed



Collector



Clutch ring

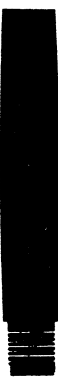

Barrel



Filler unit



Blind cap

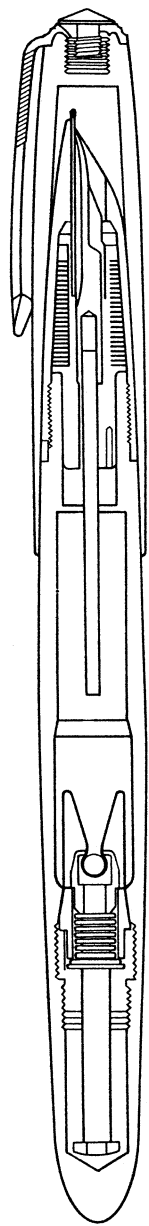

Fountain Pens

51 (New Style) Mark II

The Mark II is basically the same pen as the 51 Aero-Metric. The only real noticeable difference is that the barrel has been redesigned to bring a more up-to-date appearance. The barrel is slimmer and has a conical end and the barrel band is thinner. The pen cap is the same as the 61 pen cap, without the stamped 61 numerals.

To repair the Mark II the same basic repair procedure is used as in the repair of the 51 Aero-Metric. However, the Mark II does not have an "O" ring gasket.

The major difference in the newer version is a change in the size of the threads on the nipple assembly. Due to the different size threads, the universal nipple wrench has to be adapted with a 51 collet or a new (U.S.) disassembly wrench which was designed specifically for this model.



Fountain Pens

51 Vac-Fill Fountain Pen

Disassembly

1. Remove the cap from the barrel.
2. Extract the ink from the pen.
3. Grasp the barrel with friction palm grip, the shell with rubber covered section pliers (see illustration).



4. Pliers must grip the shell just ahead of the clutch ring to avoid breaking it.
5. With a quick snap of the wrist, twist the shell and unscrew it from the barrel.

6. The 51 Vac-fil pen front ends are of identical construction to the 51 Aero-Metric and 51 Special pens but, like the Super 21 pens, do not have an "O" ring. Continue disassembling as you would these pens. The same cleaning and inspection care must be followed.

7. To disassemble the filler unit, remove the blind cap (upper part of the barrel) by unscrewing it. Introduce the plunger in the open end of the Filler Unit Clamp (see illustration).



8. Grasp the exposed threads of the filler unit with the Filler Unit Clamp and unscrew the filler unit from the barrel (see illustration).



9. The necessity to disassemble the filler unit is dictated by the filling performance of the unit. If the pen fills well and there is no ink on the plunger, it is usually not necessary to disassemble the filler unit. The plunger should slide in and out smoothly; if it binds or sticks, replace the filler unit.

10. Clean the inside of the pen with cleaning solution and fresh water and dry thoroughly.

Assembly

Assembly of the front end of the "51" Vac-fil pens is identical to the "51" Aero-Metric and "51" Special—but no "O" ring is required.

To replace the filler unit, follow these instructions:

Clean the barrel threads of old adhesive of pieces of the old diaphragm.

1. The open end of the diaphragm of the new filler unit should be rolled back on itself and seated firmly to the shoulder on the metal coupling of the filler unit (see illustration).

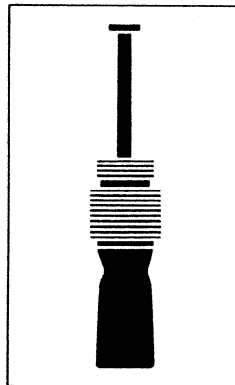

2. Grip the diaphragm directly over the metal coupling between index and middle fingers. Depress the plunger and extend the diaphragm. Insert the diaphragm straight into the back end of the pen barrel and release grip. The diaphragm will snap into position in the barrel and seat evenly on the tapered shoulder inside. Do not depress the plunger at this point (see illustration).



3. Start the threaded connection of the filler into the barrel threads, then insert the top threads of the connection into filler unit clamp. Grip and use a friction palm grip to tighten the filler unit in the barrel. Sometimes it will feel as though the filler unit is tight in the barrel when actually the clamp has contacted the back end of the barrel. To overcome this, release your grip on the filler unit clamp, back it off one or two turns, clamp down and tighten the filler into the barrel. A firm pressure should be used, but extreme pressure may cause a bulge to appear in the walls of the barrel.

4. Inspect the action of the filler unit after installation. It should return to its full length on the release stroke. Check for smooth, easy action. If a noticeable ridge appears at the joint between the blind cap and barrel, it may be remedied by further tightening of the filler unit. As a rule, tightening the filler unit connection slightly will throw the barrel and blind cap into better concentricity. For those blind cap joints which are unusually bad, it may be necessary to file or sand them down with a small file or a fine, wet strip of emery paper. Should this be necessary, restore the barrel to its original high lustre by using a buffing wheel and pumice or polish. Well equipped shops use a small hand lathe to trim off-center blind cap joints.

5. The back end of the pen is now completely reassembled. Therefore, proceed to assemble the clutch ring, collector, feed, nib and shell. Adjust the nib, following the instructions given under the "Nib Adjustment" section, page 5.

Tools Required

1. Friction palm grip.
2. Section pliers.
3. Universal nipple wrench.
4. Filler unit clamp.
5. Polish.
6. Adhesive.
7. Alcohol lamp or gas jet.
8. Small screwdriver.
9. ".51" collet.
10. Nib pliers.
11. Nib spacer.



Fountain Pens

51 Mark III

Disassembly

1. Remove the cap and barrel.

2. Fit a Mark III collet to a universal nipple wrench and clamp on to nipple threads and unscrew the shell with a friction palm grip.

3. Remove the nib and feed by pulling from the collector.

4. Twist and pull collector from the nipple and guard assembly. Where it is necessary, heat the guard and pull out. Discard nipple assembly.

Assembly

1. To reassemble, fit the Mark III nipple assembly to a Mark II guard assembly.

the nipple assembly home with a mallet.

3. Fit a Mark III barrel band and common collector.
4. Insert the feed to collector.
5. Fit the nib, hold assembly in the wrench and fit the shell. Line up one slot in the collet with the point of the shell. Remove the shell without releasing your grip of the clamp, and revolve the nib and collector to line up with the slot.

Note: The adhesive should be applied completely around the thread. This model does not gasket and is prone to leakage carelessly applied.

7. Tighten, using the friction grip.

51 Mark I (Aero) Conversion

1. Fit a 61 FHC cap assembly.

2. Fit a 51 Mark III nipple assembly, shell, barrel band and barrel.

3. If necessary, fit a 51 Mark II guard. The early 51 Mark I guards will not allow the barrel to be screwed fully on.

51 Mark II Conversion

Fit a 51 Mark III nipple assembly, shell, barrel band and barrel.

1. Alcohol lamp or gas jet.
2. Mallet.
3. Universal nipple wrench and 51 collet.
4. Stainless steel beaker.
5. Friction palm grip.
6. Small screwdriver.
7. Adhesive.

Tools Required

Fountain Pens

50 (Falcon) Fountain Pen

Repairs

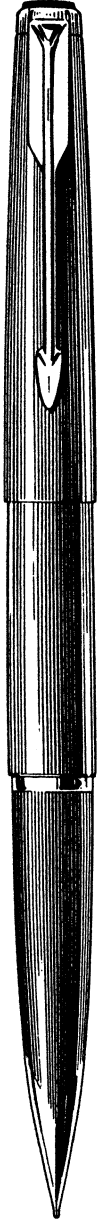

Fountain Pens

50 (Falcon) Fountain Pen

Exploded drawing

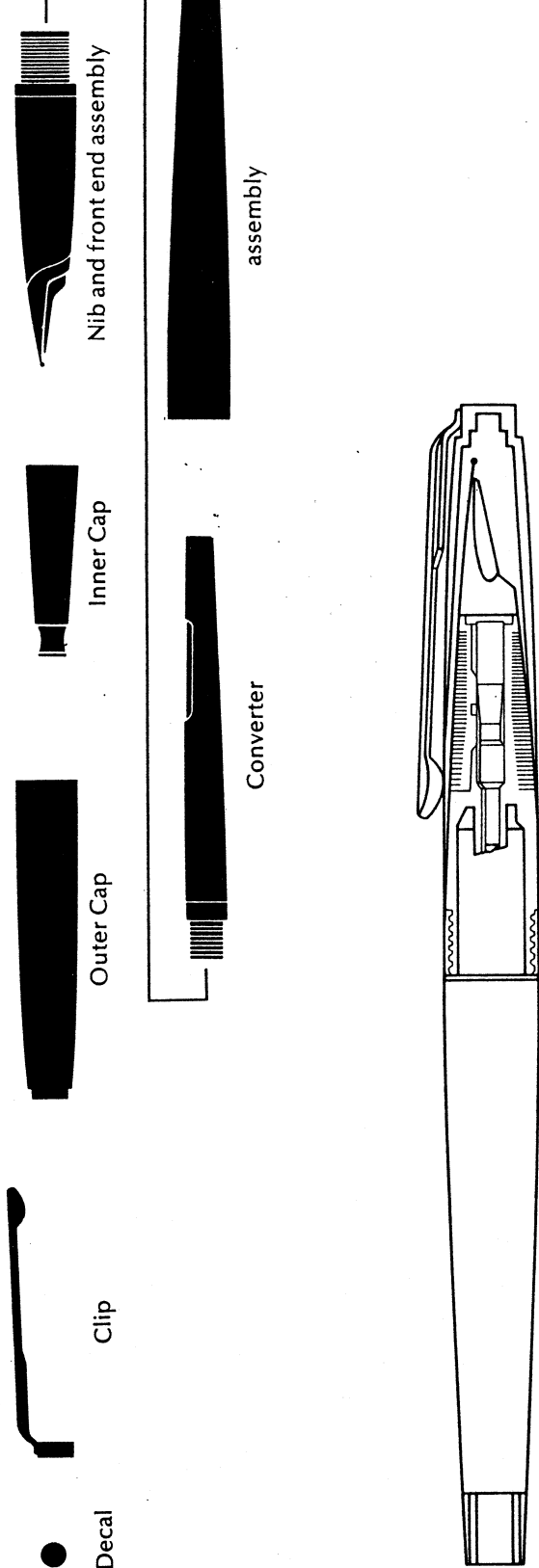

Fountain Pens

50 (Falcon) Fountain Pen

Disassembly

1. Remove cap and barrel.
2. If pen is equipped with a converter, extract the ink and remove the converter or, in

Assembly

1. Front end is only available as a complete assembly. Replacement is accomplished by using factory assembled and tested unit. Flow adjustments to the nib are accomplished in the normal manner. When carrying out nib grade changes, ensure that assemblies fit for re-use are washed out before storing.
2. Barrel assembly consists of the barrel and connector. In the event that a connector should become loose, it can be replaced using epoxy cement. In situations where the shell has

become detached from the connector, the following procedure should be followed: Clean the internal bore of the shell and remove any traces of adhesive. Fit the customer's original feed and barrel band to NEW connector. Fit

a NEW gasket. Apply adhesive between gasket and barrel band, spread it completely around the full circumference of this area. Install the shell and line up with the feed, wipe off surplus adhesive and allow to dry, point down.

Disassembly of Clip Sprung or Broken

- Remove old clip by gripping clip ring with repair kit pliers—rotate slightly and ease off clip, holding cap with friction palm grip.

Note: Care should be exercised when removing clip not to distort clip location ring on cap.

Assembly of Clip

- Apply small amount of adhesive to clip location ring on cap. Align clip with the "Parker" stamping on the outer cap. Start the clip onto the outer cap by placing the head against a firm surface and

- applying pressure on the outer cap with the aid of a friction palm grip, so as to force the clip onto the outer cap. To complete this assembly, place the head of the clip over the hole (.265" dia.) in a

fitting block and, using a small mallet, tap on the large open end of the outer cap until the edge of the clip rests against the shoulder of the outer cap. Since the inner cap decal

assembly may become damaged in the above process, replacement of this part is recommended. This can be accomplished as outlined below:

Disassembly of Inner Cap Decal Assembly

- Remove inner cap by tapping out, using repair kit punch and wooden mallet.

Assembly of Inner Cap Decal Assembly

- Install the new inner cap decal assembly as follows: Insert inner cap decal assembly into the large open end of the clip and outer cap

mallet, gently tap on the rod until the top flange on the inner cap decal assembly is completely through the clip ring.

Tools Required

1. Alcohol lamp or gas jet.
2. Friction palm grip.
3. Nib pliers.
4. Nib spacer.
5. Adhesive.
6. Small mallet.

Fountain Pens

Model 45 Fountain Pen

Repairs



Fountain Pens

Model 45 Fountain Pen

Exploded drawing

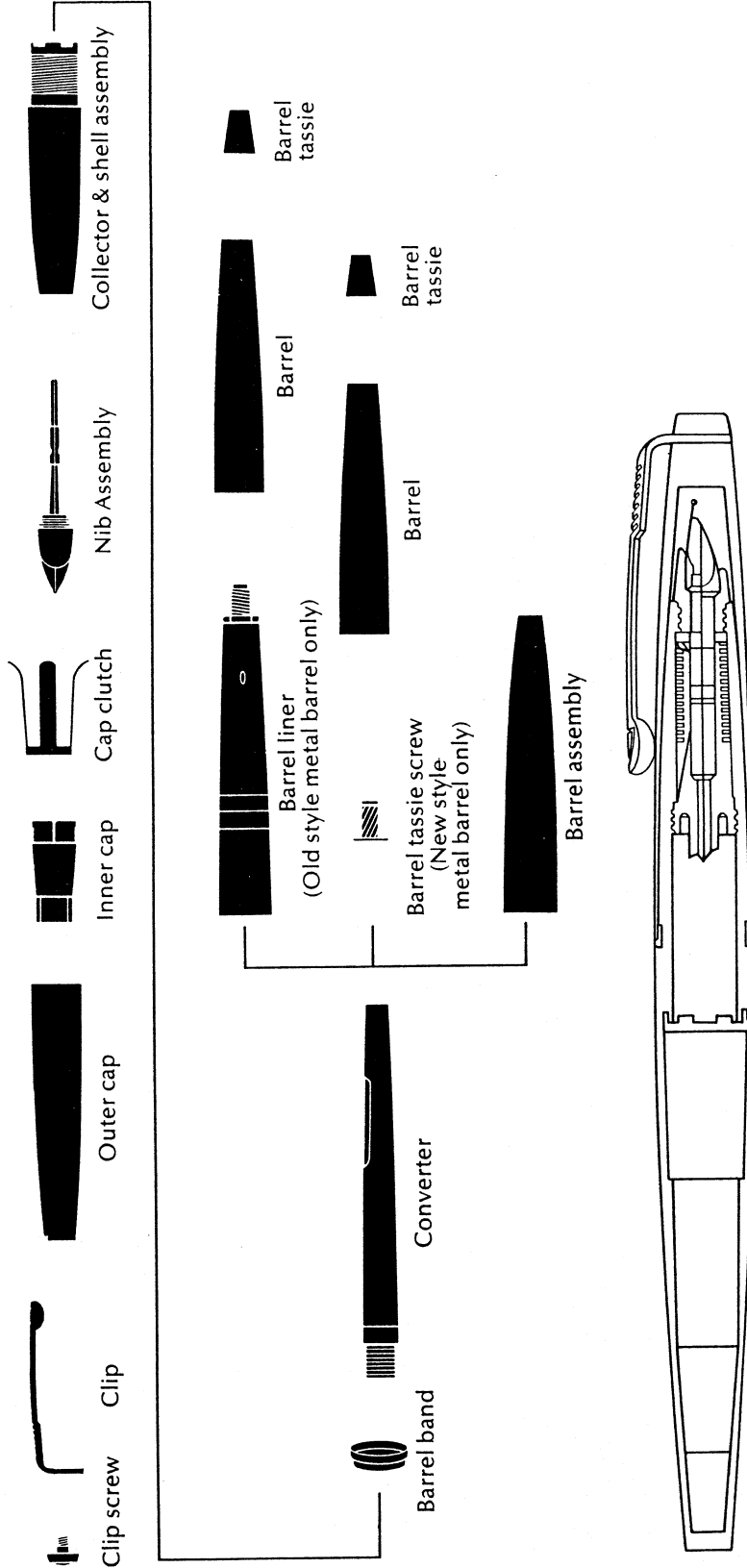

Fountain Pens

Model 45 Fountain Pen

Disassembly

1. Remove cap and barrel.
2. If pen is equipped with a converter, extract the ink and remove the converter or, in the case of a cartridge, remove the cartridge.

3. Remove nib assembly by grasping the nib collar with your fingers and unthread it from the shell.
- *4. Do not handle the back end of the feed.

5. To exchange the nib, pull it straight out of the nib collar with nib pliers.
6. The feed is easily extracted through the front end of nib collar.

*Note: If the nib is damaged, it is recommended the complete nib assembly be replaced.

Reassembly

1. Hold the nib over the feed as shown, and insert it all the way into the nib collar.
2. If it is necessary to replace the nib or feed, immerse the front end assembly to the threads of the nib collar, in boiling water for ten seconds to assure proper nib-feed contact. If this is not done, the pen may not write properly.

3. If the pen does not write properly after the hot water treatment, remove the nib and bend the heel (rear end) slightly down with a pair of nib pliers, then repeat the immersion treatment.
4. Apply wax to the threads of the nib collar, nib, feed assembly, and turn into the shell. Replace the cartridge or converter filler.

5. Test the pen for ink flow and smoothness.
Note: For further disassembly and assembly instructions for Model 45 see: Section entitled "Nibs & Their Repair," page 5.
Section entitled "Fault Finding," page 3.
Section entitled "45 Cap Assembly," page 51.

Tools Required

1. Alcohol lamp or gas jet.
2. Friction palm grip.
3. Nib pliers.
4. Nib spacer.
5. Stainless steel beaker.

Fountain Pens

Model 25 Fountain Pen

Repairs



Fountain Pens

Model 25 Fountain Pen

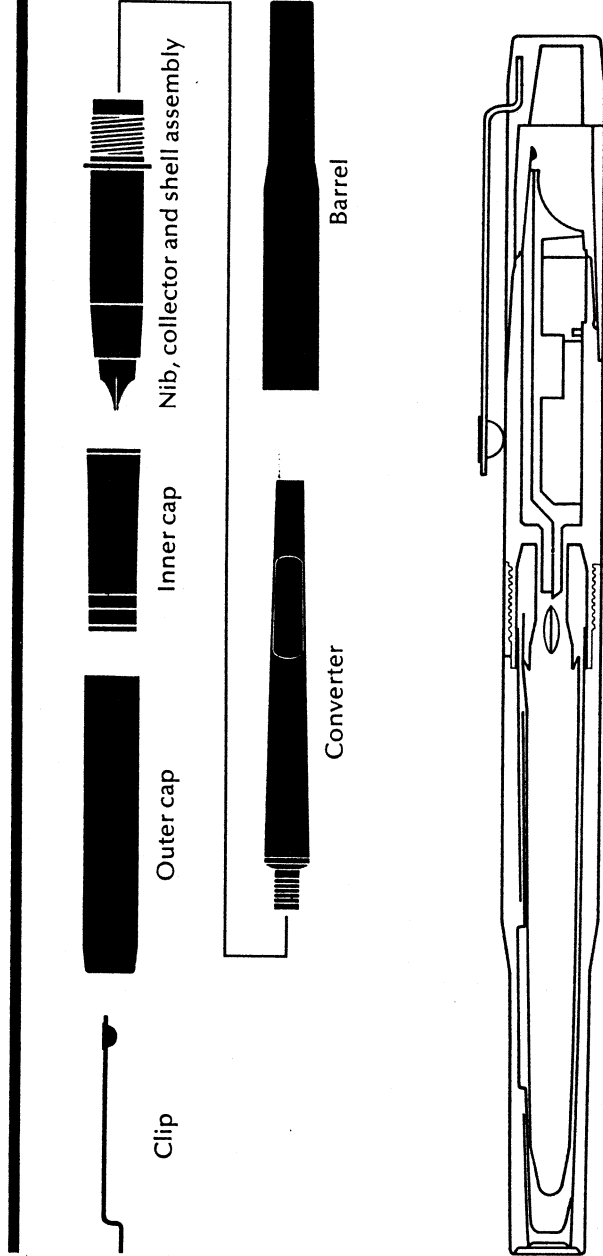

Exploded drawing

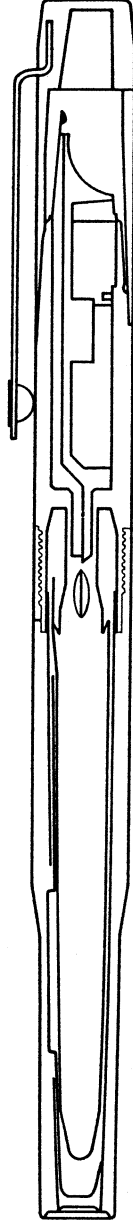

Fountain Pens

Model 25 Fountain Pen

Disassembly

1. Remove cap and barrel.
2. If a pen is equipped with a converter, extract the ink and remove the converter or, in the case of a cartridge, remove the cartridge.
3. Front end is only available as a complete assembly.
Disassembly and assembly can not be satisfactorily carried out in the field.
When carrying out the nib grade changes, ensure that assemblies fit for re-use are washed out before storing.
4. To disassemble cap assembly, stand cap upright on bench and drive inner cap out of cap using knock-out pin and mallet. Unhook clip without distorting slot in cap.
5. Always use new inner cap.



Assembly

Hook clip to cap, insert new inner cap. Be sure the flat on the side is in line with clip. Stand cap upside down on bench and tap inner cap firmly home with cap arbor and mallet.

Tools Required

1. Knock-out pin.
2. Mallet.
3. Nib spacer.
4. Pen cap arbor.

Fountain Pens

Model 15, Mixy (Jotter Fountain Pen)

Repairs

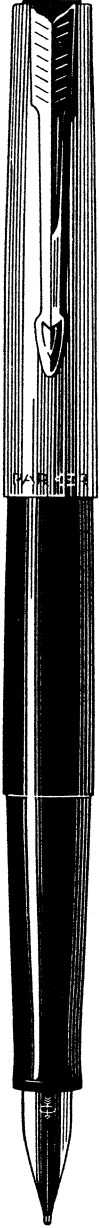

Fountain Pens

Model 15, Mixy (Jotter Fountain Pen)

Exploded drawing

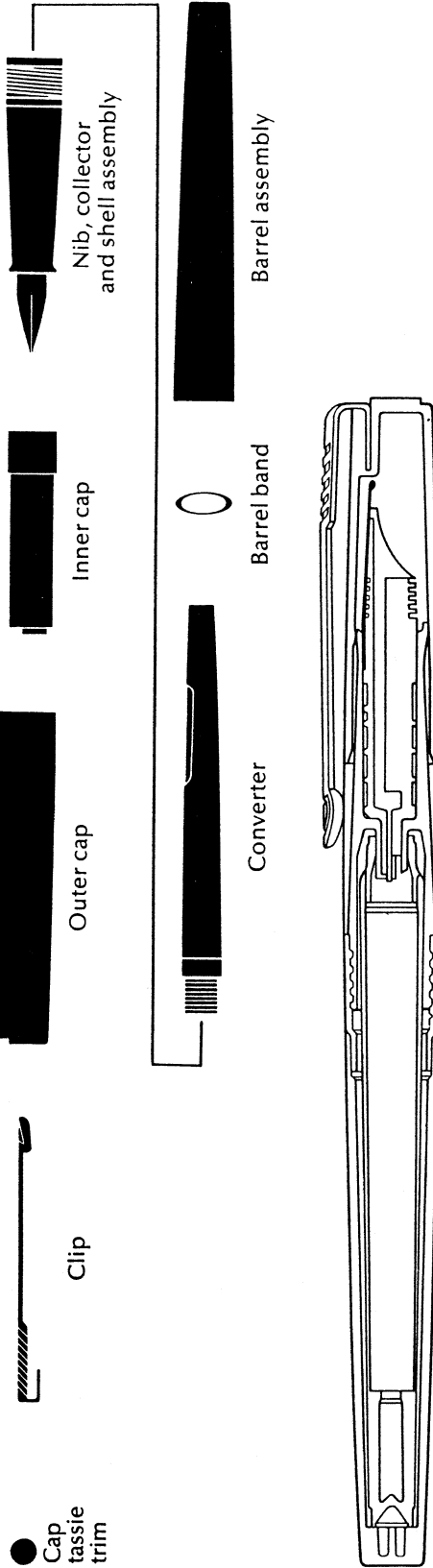

Fountain Pens

Model 15, Mixy, Jotter Fountain Pen



Disassembly

1. Remove cap and barrel.
2. If pen is equipped with a converter, extract the ink and remove the converter or, in the case of a cartridge, remove the cartridge.
3. The front end is only a complete assembly. Disassembly and assembly can not be satisfactorily carried out in the field.
4. When carrying out nib changes, ensure that assemblies fit for re-use are washed out before storing.
5. To disassemble the cap (MIXY 15), stand the cap upright on the bench. Drive the inner cap out of the cap by using the knock-out pin and mallet.
6. The barrel assembly is only available as a complete assembly.

Assembly

To reassemble the cap (MIXY 15), place the inner cap on the cap arbor, insert into the cap. Ensure that the clip slot is in line with the cap cutout. Locate the flange of the clip into the slot and press against a hard surface.

Note: To disassemble and assemble the Model 15 or Jotter fountain pen cap see the section on page 51, 45 cap disassembly and assembly.

Tools Required

1. Alcohol lamp or gas jet.
2. Friction palm grip.
3. Cap arbor.
4. Nib pliers.
5. Nib spacer.

Fountain Pens

Arrow Fountain Pen

Repairs



Fountain Pens

Arrow Fountain Pen

Exploded Drawing

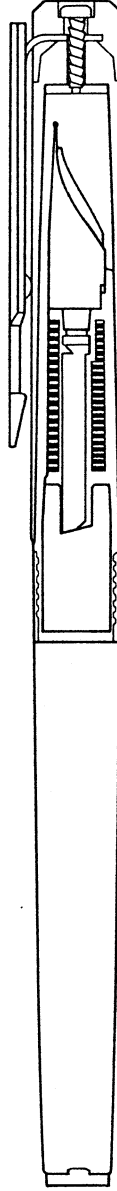
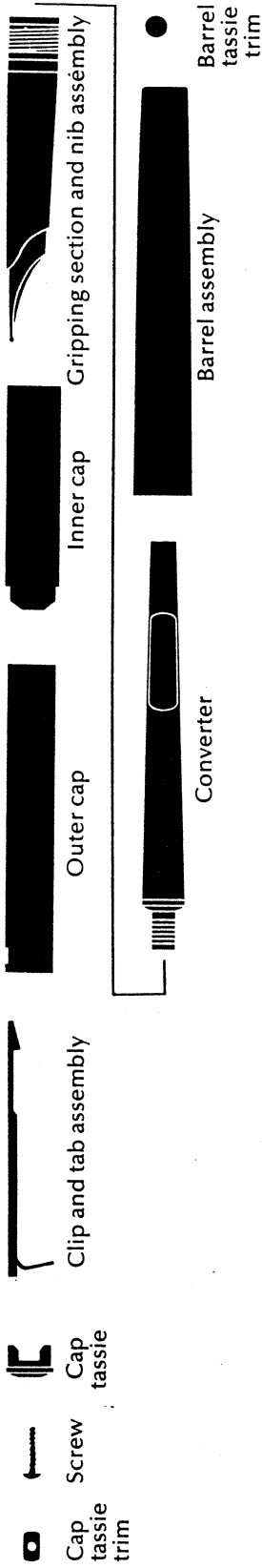

Fountain Pens

Arrow Fountain Pen

50

Disassembly

1. Remove the cap and barrel.
 2. If the pen is equipped with a converter, extract the ink and remove the converter; in the case of a cartridge, remove the cartridge.
 3. Only minor nib adjustments can be performed on the nib since the gripping section and nib assembly are only available from the factory as a complete assembly.
 4. No repairs should be necessary on the barrel assembly other than replacing the tassie trim or reconnecting the barrel connector. When re cementing the barrel connector it is important that it is recessed in from the open end of the barrel the proper distance. The best method to determine the distance is to compare it with a new barrel.
 5. The cap can be disassembled so as to make clip and tab assembly and cap tassie replacements.
- First, remove the cap tassie trim by piercing it in the center with a pointed instrument and lifting it up and away from the cap tassie. Once the cap tassie trim has been removed the exposed screw can then be turned out with a small Phillips head screwdriver. The clip and tab assembly can then be removed by pulling it straight out from the slot in the side of the cap and, if required, the cap tassie can be removed by pulling it straight out from the top of the cap.
- If the inner cap requires replacement due to failure or because it has become loose within the cap, it should be replaced. This can be accomplished by applying heat, if necessary to the outer surface of the cap and then stand it upright on a firm surface and drive the inner cap down toward the open end of the cap with a driving rod.

Assembly

1. If the inner cap was removed during the disassembly operation, first apply an epoxy cement to the outer surface of the inner cap and start it into the outer cap. Since the inside of the inner cap is slotted to accept a regular screwdriver, it can be forced up toward the top of the outer cap, with a screwdriver, until the raised portion of the inner cap is approximately three-fourths above the lower edge of the clip opening in the outer cap. Next, insert the clip tab of the clip and align the raised portion of the inner cap with the clip tab. Then install the cap tassie so that the slotted area is aligned with the clip tab and the raised portion of the inner cap. While holding the cap tassie firmly against the top edge of the outer cap, turn the screw
- firmly into the hole in the inner cap. Allow sufficient time for the epoxy cement to dry.
- If it was not necessary to remove the inner cap, reassemble the cap as follows: Install the cap tassie if it was removed during the disassembly operation. Align the slotted area of the cap tassie with the raised area on the inner cap. Then insert the tab of the clip and tab assembly into the slot in the side
- of the cap. Line up the hole in the clip tab with the hole in the inner cap and insert the screw. Turn the screw firmly into the inner cap with a small Phillips head screwdriver. Apply adhesive to the recessed area of the cap tassie and install a new cap tassie trim. Wipe any excessive adhesive from the cap tassie.

Tools Required

1. Alcohol lamp or gas jet
2. Small Phillips head screwdriver
3. Nib spacer
4. Nib pliers
5. Driving rod
6. Mallet

Fountain Pens

Arrow Fountain Pen
(Revision I-1982)

Repairs



Fountain Pens

Arrow Fountain Pen (Revision I-1982)

502

Exploded Drawing

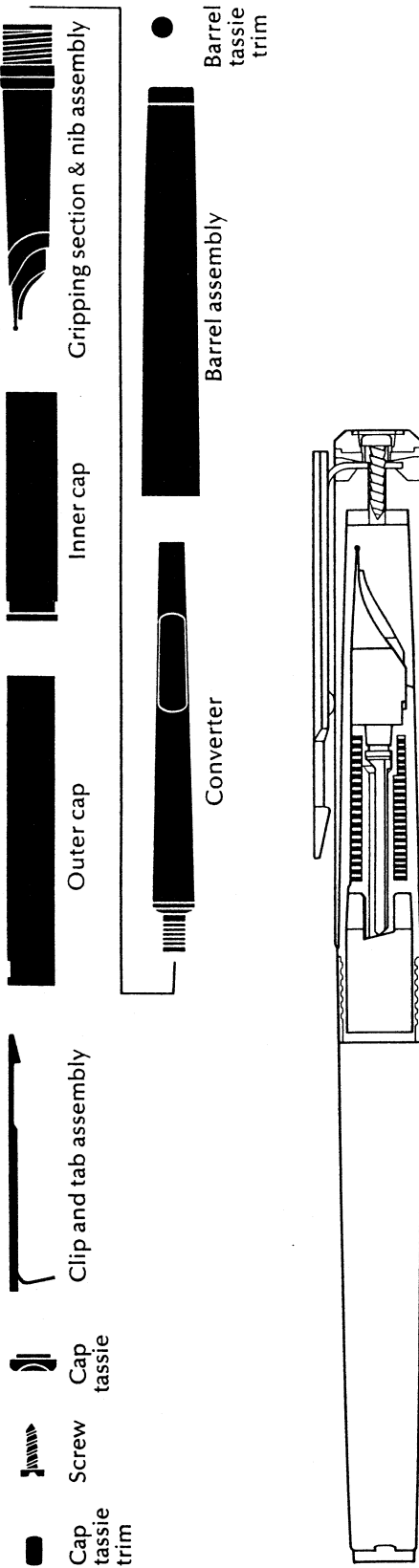

Fountain Pens

Arrow Fountain Pen (Revision I-1982)

50.3

Disassembly

1. Remove the cap and barrel.
2. If the pen is equipped with a converter, extract the ink and remove the converter; in the case of a cartridge, remove the cartridge.
3. Only the minor nib adjustments can be performed on the nib since the gripping section and nib assembly are only available from the factory as a complete assembly.
4. No repairs should be necessary on the barrel assembly other than replacing the tassie trim or re cementing the barrel connector. When re cementing the barrel connector it is important that it be recessed in from the open end of the barrel the proper distance. The best method to determine the distance is to compare it with a new barrel.
5. The cap can be disassembled to make clip and tab assembly and cap tassie replacements. First, remove the cap tassie trim by piercing it in the center with a pointed instrument and lifting it up and away from the cap tassie. Once the cap tassie trim has been removed the exposed screw can then be turned out with a small Phillips head screwdriver. The clip and tab assembly can then be removed by pulling it straight out from the slot in the side of the cap. If damaged, the cap tassie should be replaced.

If the inner cap requires replacement due to failure or misuse, it should be replaced. This can be accomplished once the cap tassie trim, screw, cap tassie, and clip and tab assembly have been removed. The inner cap will slide out by pushing gently on the closed end of the inner cap.

Assembly

1. If the inner cap was removed during the disassembly operation, insert the new style inner cap into the outer cap. Then align the slot in the inner cap with the slot in the outer cap. Insert the tab of the clip and tab assembly into the slot in the side of the outer cap and into the inner cap. Line up the hole in the clip and tab assembly with the hole in the inner cap. Place the cap tassie on the outer cap and insert the screw. Note, the length of the recess should align with the Arrow clip. Turn the screw firmly with a small Phillips head screwdriver. Apply adhesive to the recessed area of the cap tassie and install a new style black tassie trim. Wipe any excessive adhesive from the cap tassie. Allow sufficient time for adhesive to dry.
2. Alcohol lamp or gas jet.
3. Nib spacer.
4. Nib pliers.
5. Magnifying glass.

Tools Required

Fountain Pens

Recently Manufactured 61, 51 Aero-Metric,
45, Jotter Fountain Pen Caps

51

1. The new style inner cap and clutch are used in these pens.
2. After the clip has been removed, the inner cap and clutch can be removed with a knock-out rod.
3. This new type inner cap and clutch can be installed in the older model pens.

Super 21 Pen (Recently Manufactured Super 21 Pen)

Older model pens do not have a cap clutch. Removal of the inner cap can be accomplished by removing the clip. Recently manufactured Super 21 has an

inner cap and cap clutch. After the clip has been removed, the inner cap and clutch can be removed with a knock-out rod.

45, 21, Jotter Fountain Pen

Hold the cap onto the pen arbor. Using the friction palm grip press the clip screw against the grip, rotate the tool.

Fountain Pens

51 Vac-fil, Early Manufactured 61, 51 Aero-Metric Pen Caps

52

Repairs

Removal of Inner Cap and Clutch

1. It is necessary to burnish out the slight bevel at the edge of the opening in order to extract the cap clutch. This operation can be performed with the tip of the handles of the Bernard pliers by rotating the cap against the tip, as pictured.

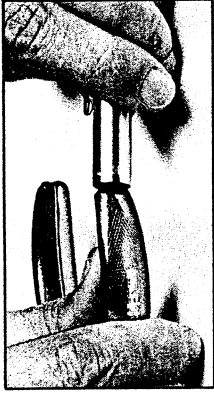

2. If bevel has been removed properly, remove the clutch with a hook shaped tool.

3. An alternative method, after removing the pen clip: Heat the cap over a flame or immerse the cap into boiling water. The plastic inner cap will soften. The inner cap can be forced out by using a metal knock-out rod.

Recently Manufactured 61 and 51 Aero-Metric and 45 Pens

Assembly of Caps

1. To reassemble these caps, place the inner cap and cap clutch on the cap arbor and insert the assembly straight into the cap.

2. Place clip in position and thread the clip screw tightly, using a friction palm grip.

Super 21 Pen Cap—Recently Manufactured Super 21

1. To reassemble the cap, place an inner cap on the cap arbor.

2. Insert the inner cap and clutch into the cap and replace clip screw.

3. Recently manufactured Super 21: To reassemble these caps, place the inner cap and cap clutch on the cap arbor and insert the assembly straight into the cap.

Tools Required

1. Alcohol lamp or gas jet.
2. Cap arbor.
3. Knock-out rod.
4. Friction palm grip.
5. Small screwdriver.

Fountain Pens

FP-1

Repairs



Fountain Pens

FP-1

54

Repairs

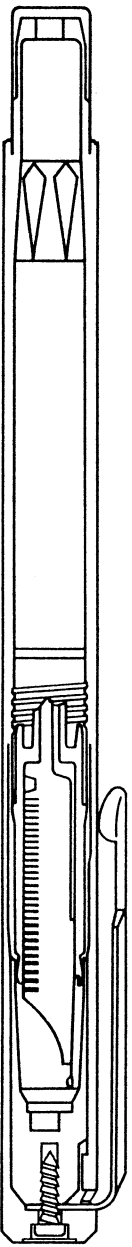
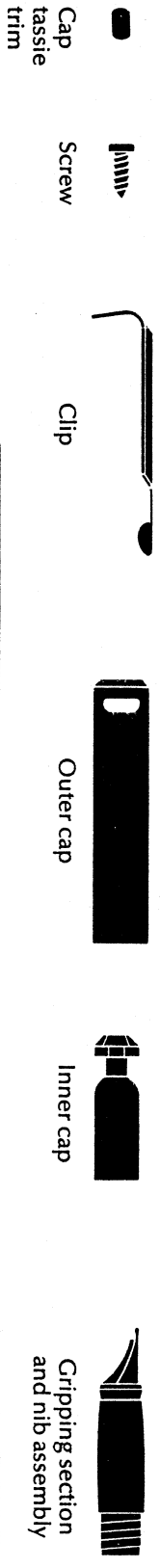

Exploded Drawing

Disassembly

1. Remove the cap and barrel.
2. The pen is equipped with a cartridge. Remove the cartridge.
3. Only minor nib adjustments can be performed on the nib since the gripping section and nib

Assembly

1. If the inner cap was removed during the disassembly operation, insert the inner cap into the cap with a .25 ball pen cap arbor, or by

- assembly are only available from the factory as a complete assembly.
4. Any problems with the barrel assembly require replacement, since it is available as a complete assembly only.

- using the pen barrel and shell assembly to position the inner cap.
2. Insert the clip into the slot on the side of the outer cap. Align the

5. The cap can be disassembled to make clip replacements. First, remove the tassie trim by piercing it in the center with a pointed instrument and lifting it up and away from the cap. Once the tassie trim has been removed the exposed screw can be turned out

- hole in the clip with the hole in the inner cap, turn the screw into the hole in the inner cap with a small Phillips head screwdriver. Apply adhesive to the recessed area of

- with a small Phillips head screwdriver. The clip can then be removed by pulling it straight out from the slot in the side of the cap. The inner cap will be released, if replacement is required due to failure.

- the cap and install a new white cap tassie trim, for identification purposes.

Tools Required

1. Alcohol lamp or gas jet.
2. Nib spacer.
3. Small Phillips head screwdriver.
4. Magnifying glass.
5. Stainless steel beaker.

Fountain Pens

Premier

Repairs



Fountain Pens

Premier



Exploded Drawing

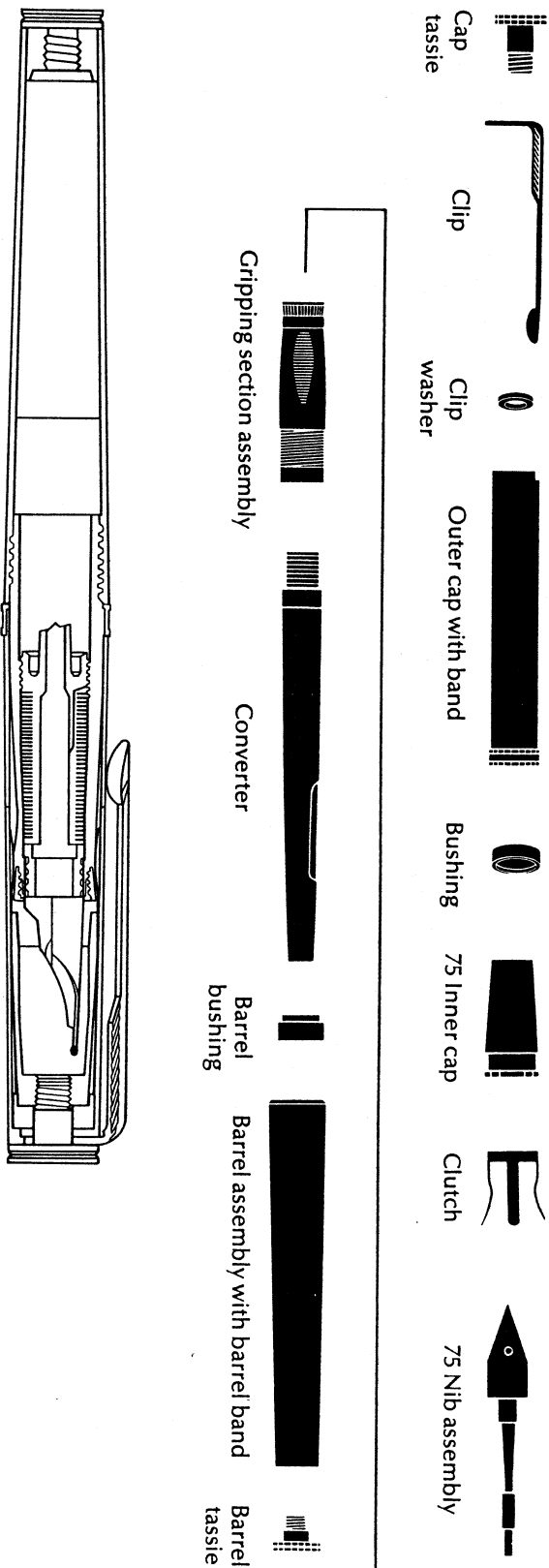

Fountain Pens

Premier



Disassembly

1. Remove the cap and barrel.
2. If the pen is equipped with a converter, extract the ink and remove the converter; or, in the case of a cartridge, remove the cartridge.
3. Remove the nib assembly by pulling straight out (it is not threaded).
4. Do not handle the back end of the feed.
5. To disassemble the cap, insert the cap arbor into the inner cap and with the aid of a cap tassel tool or a friction palm grip, twist the cap tassel in a counterclockwise direction. Apply gentle heat to the cap tassel if difficulty is found removing it. If a cap tassel becomes damaged with this method a new one must be fitted.
6. To disassemble the barrel, with the aid of a friction palm grip and screwdriver inserted in barrel, twist the barrel tassel in a counterclockwise direction. Apply gentle heat if difficulty is found in removing it.

Assembly

1. Insert the nib assembly into the gripping section assembly by pushing straight in.
2. Replace the converter and fill with cleaning solution. Then use a centrifuge to clean out the solution.
3. Fill the pen with ink and test for smoothness and flow.
4. After proper adjustments are made, remove ink by centrifuge, fill with cleaning solution and remove by centrifuging. Then fill with conditioner and centrifuge again.
5. Should either the outer cap or barrel bands be missing or damaged, apply adhesive and fit. Wipe off any excessive adhesive. Allow the adhesive sufficient time to dry.
6. To assemble the cap:
 - a. Assemble the bushing, inner cap and clutch and insert parts into the cap with a pen arbor. (Note: the clutch fingers are set differently from the 75 pen clutch.)
 - b. Locate the washer at the clip end of the cap and insert the clip in the cap so that the clip is resting in the notched out position of the cap.
7. Should a barrel tassel be removed, apply adhesive to the threads of the barrel tassel. Locate barrel bushing and hold in position with screwdriver and tighten firmly in a clockwise direction using a friction palm grip.
8. Due to the particular design of the 75 nib and the very exacting tolerances, if one comes in that is even slightly sprung, be careful in adjusting it. It can be very easily and permanently sprung out of tolerance.

See section entitled "Nibs and Their Repair", page 5.

See section entitled "Fault Findings", pages 3, 4, and 5.

Tools Required

1. Eye glass.
2. Pen cap arbor.
3. Friction palm grip.
4. Nib pliers.
5. Nib spacing tool.
6. Alcohol lamp or gas jet.
7. Stainless steel beaker and stand.
8. Screwdriver.
9. Cap tassel tool.